



## A hybrid approach based on the genetic algorithm and Monte Carlo method to optimize the 3-D radiant furnaces

Kamkari, B., Mahjoub, S., & Darvishvand, L. (2015). A hybrid approach based on the genetic algorithm and Monte Carlo method to optimize the 3-D radiant furnaces. *ADMT Journal*, 8(3), 1-9.

[Link to publication record in Ulster University Research Portal](#)

**Published in:**  
ADMT Journal

**Publication Status:**  
Published (in print/issue): 01/09/2015

**Document Version**  
Publisher's PDF, also known as Version of record

**Document Licence:**  
CC BY

### **General rights**

The copyright and moral rights to the output are retained by the output author(s), unless otherwise stated by the document licence.

Unless otherwise stated, users are permitted to download a copy of the output for personal study or non-commercial research and are permitted to freely distribute the URL of the output. They are not permitted to alter, reproduce, distribute or make any commercial use of the output without obtaining the permission of the author(s).

If the document is licenced under Creative Commons, the rights of users of the documents can be found at <https://creativecommons.org/share-your-work/ccllicenses/>.

### **Take down policy**

The Research Portal is Ulster University's institutional repository that provides access to Ulster's research outputs. Every effort has been made to ensure that content in the Research Portal does not infringe any person's rights, or applicable UK laws. If you discover content in the Research Portal that you believe breaches copyright or violates any law, please contact [pure-support@ulster.ac.uk](mailto:pure-support@ulster.ac.uk)

# A Hybrid Approach Based on the Genetic Algorithm and Monte Carlo Method to Optimize the 3-D Radiant Furnaces

## B. Kamkari\*

Young Researchers and Elite Club, Yadegar-e-Imam Khomein (RAH) Shahre-Rey Branch, Islamic Azad University, Tehran, Iran

E-mail: kamkari@ut.ac.ir

\*Corresponding author

## Sh. Mahjoub

Department of Engineering, Majlesi branch, Islamic Azad University, Isfahan, Iran

E-mail: sh\_mahjoub@yahoo.com

## L. Darvishvand

Department of Mechanical Engineering, University of Tehran, Iran

E-mail: l.darvishvand@ut.ac.ir

Received: 6 January 2015, Revised: 12 March 2015, Accepted: 15 March 2015

**Abstract:** This study presents an optimization methodology to obtain the uniform thermal conditions over the 3-D design body (DB) in 3-D radiant furnaces. For uniform thermal conditions on the DB surfaces, optimal temperature of the heater and the best location of the DB inside the furnace are obtained by minimizing an objective function. The radiative heat transfer problem is solved on the basis of the Monte Carlo method (MCM) to calculate the heat fluxes on the DB surfaces. The genetic algorithm (GA) is used to minimize the objective function defined based on the calculated and desired heat fluxes. The results indicate that thermal conditions on the DB surfaces are greatly influenced by the location of the DB and heater temperature. It is concluded that the introduced method is well capable to achieve the uniform thermal conditions on the DB surfaces by finding the optimal values for temperature of the heater and the best location for the DB inside the radiant furnace.

**Keywords:** Genetic algorithm, Inverse Boundary Design Problems, Monte Carlo Method, Radiation Heat Transfer

**Reference:** Kamkari, B., Mahjoub, Sh., and Darvishvand, L., "A Hybrid Approach Based on the Genetic Algorithm and Monte Carlo Method to Optimize the 3-D Radiant Furnaces", Int J of Advanced Design and Manufacturing Technology, Vol. 8/No. 2, 2015, pp. 67-75.

**Biographical notes:** **B. Kamkari** is currently Assistant Professor at the Department of Mechanical Engineering of Yadegar-e-Imam Khomeini (RAH) Branch, Islamic Azad University, Tehran, Iran. He received his MSc in Mechanical Engineering from Isfahan University of Technology, and his PhD from Tehran University. **S. Mahjoub** is a PhD candidate in the School of Mechanical Engineering, College of Engineering, University of Tehran, Tehran, Iran. He received his MSc in mechanical engineering in 2003 from Sharif University of Technology, Tehran, Iran. He is currently a lecturer of thermo-fluid in the Department of Engineering, Majlesi Branch, Islamic Azad University, Isfahan, Iran. **L. Darvishvand** received her MSc in mechanical engineering in 2011, from the School of Mechanical Engineering, College of Engineering, University of Tehran, Tehran, Iran. She is currently working on the radiative heat transfer and design of radiant enclosures.

## 1 INTRODUCTION

Radiant furnaces are used in various engineering applications such as semiconductor production, thermal operation, surface coating and drying processes. Among various heating devices, radiant furnaces are able to produce desired uniform thermal conditions, heat flux and temperature on the design surfaces. Providing uniform thermal conditions on the design body (DB) surfaces requires considering some system parameters including arrangement and powers of the heaters, geometry and material properties of the furnace and location of the DB inside the furnace. Design of the radiant furnaces with the objective of satisfying the uniform thermal conditions over the DB surfaces is categorized as inverse boundary design problems which are known to be ill-posed [1]. A good number of studies have been given in literature to design the radiant furnaces using special mathematical tools such as regularization and optimization tools [1-3], [4-9]. Daun presented a comprehensive review of applying regularization methods to the inverse design of thermal systems [2].

Recently, optimization methods have been significantly applied in inverse radiative heat transfer problems [8-14]. In optimization methods, an objective function which depends on the design parameters is defined so that its minimum point corresponds to the ideal design outcome. This objective function which depends on the design parameters is minimized by employing the specialized numerical algorithm. Therefore, optimization methods change the design parameters systematically to satisfy the design goals.

Among the optimization methods, GA has received much attention for its flexibility, globality, robustness, parallelism and simplicity. Gosselin et al., [15] reviewed the utilization of genetic algorithms in heat transfer problems. They mentioned that inverse heat transfer problems are one of the three main families of heat transfer problems which are solved using GA. Safavinejad et al. [6] implemented micro-genetic algorithm to optimize the number and location of the heaters in 2-D radiant enclosures composed of the specular and diffuse surfaces. They also studied the effects of the refractory surface characteristics (i.e., diffuse and/or specular) on the optimal solution. In another study, Safavinejad et al. used this method to solve the inverse boundary design problem in 2-D radiant enclosures with absorbing-emitting media [7]. For the uniform thermal conditions, Chopade et al. [13] investigated the constraints on the size of a 3-D design object that can be placed inside a 3-D radiant furnace. They found the constraints on the size of the design objects that can have uniform thermal conditions.

Monte Carlo method (MCM) is one of the most efficient commonly used numerical solutions of the radiation heat transfer problems. In a good study, Howell [16] presented a comprehensive review of applying the MCM in radiative heat transfer. The MCM simulates the radiation heat transfer by tracing the history of a random sample of photons from their points of emission until absorbing all of them.

To the best of the authors knowledge, none of the previous works in design of radiant furnaces, has employed MCM combined with the GA. Also, the effect of location of the 3-D DB on uniformity of the heat fluxes over the DB surfaces has not been considered before. Hence, in this study, effects of the location of the DB as well as the temperature of the heater have been considered to produce the desired uniform thermal conditions on the surfaces of the 3-D DB. The DB is located inside a rectangular radiant furnace with transparent medium. To achieve the uniform thermal condition, the optimal temperature of the heater and the best location of the DB have been obtained. The MCM has been used to solve the direct radiative heat transfer formulated based on the total diffuse-specular radiation distribution factor (RDF). The GA has been employed to find the best location of the DB and temperatures of the heaters by minimizing the objective function defined based on the sum of the square error between calculated and desired heat fluxes on the DB.

## 2 PROBLEM FORMULATION

### 2.1. Optimization Strategy

Fig. 1 shows the geometry of the problem under consideration. The rectangular furnace is equipped with a heater on its top wall. The other surfaces of the furnace are adiabatic which are assumed to be diffuse-specular reflectors with a specularity ratio of 0.8 and a reflectivity of one. That is, they reflect the entire irradiations from other surfaces. The heater and DB surfaces are diffuse emitters with emissivity values of 0.8 and 0.4, respectively. They are also considered to be diffuse-specular reflectors with a specularity ratio of 0.2. The surfaces of the DB and furnace are identified with numbers 1 to 6 for the DB and 6 to 12 for the furnace.

The aims of this optimization problem are to find the temperature of the heater and the best location of the DB to produce a uniform heat flux of  $100 \text{ kW/m}^2$  over all surfaces of the DB with specified temperature of  $500^\circ\text{K}$ . This is accomplished first by specifying the desired temperature over the DB surfaces, then, obtaining the heat fluxes on the surfaces of the DB,

afterwards, defining the objective function using these calculated heat fluxes as follows,

$$F = \frac{\sqrt{\sum_{i=1}^{N_d} (q_c''(i) - q_d'')^2}}{N_d} \quad (1)$$

Where  $q_c''$  and  $q_d''$  are calculated and desired heat fluxes over the DB surfaces, respectively.  $N_d$  is the number of the DB surfaces.

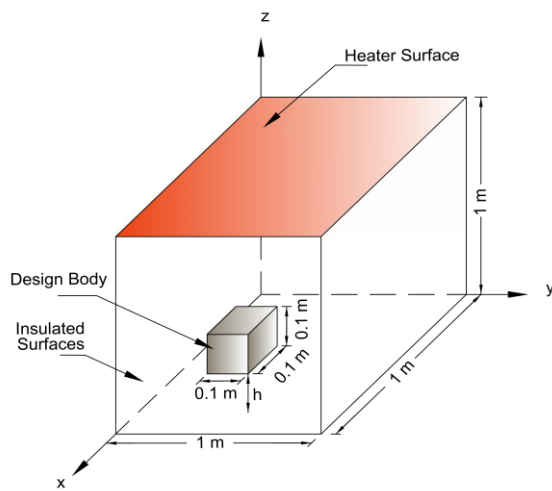

Fig. 1 Schematic of the 3-D radiant furnace and design body

The objective function is subject to the following constraints,

$$\begin{cases} 0.1 \leq x_c \leq 0.5 & (m) \\ 0.1 \leq y_c \leq 0.5 & (m) \\ 0.1 \leq z_c \leq 0.5 & (m) \\ 1000 \leq T_H \leq 4000 & (K) \end{cases} \quad (2)$$

These constraints are according to the limitations of the furnace dimensions and power of the heater. Since the bottom of the radiant furnace is symmetrical about the X and Y axis, to avoid repetitions of locations, the problem is solved in a quadrant. To study the effect of the location of the DB, some possible locations are chosen in a quadrant and their coordinates are given in Table 1.

By minimizing the objective function with respect to the unknown parameters using the GA method, the desired thermal conditions on the DB surfaces are achieved. The radiative heat transfer problem is solved using the MCM. A brief formulation for the MCM is provided in the following section. Further details of the MCM can be found in [17], [18].

Table 1 Some possible locations of the DB inside the furnace

Case No.	Center coordinates of design body
1	(0.1, 0.1, 0.1)
2	(0.1, 0.3, 0.1)
3	(0.1, 0.5, 0.1)
4	(0.3,0.3,0.1)
5	(0.3,0.5,0.1)
6	(0.5,0.5,0.1)
7	(0.1,0.1,0.3)
8	(0.1,0.3,0.3)
9	(0.1,0.5,0.3)
10	(0.3,0.3,0.3)
11	(0.3,0.5,0.3)
12	(0.5,0.5,0.3)
13	(0.1,0.1,0.5)
14	(0.1,0.3,0.5)
15	(0.1,0.5,0.5)
16	(0.3,0.3,0.5)
17	(0.3,0.5,0.5)
18	(0.5,0.5,0.5)

### 2.2. Direct radiative heat transfer problem

In this study, the MCM based on the total radiation distribution factor (RDF), is applied to model the radiative heat transfer. The RDF is the fraction of total radiation emitted diffusely from surface  $i$  and absorbed by surface  $j$ , due to direct radiation and to all possible diffuse and specular reflections within the enclosure [18]. Based on the RDF definition, the net heat flux from surface  $i$  in a enclosure composed of the  $N_e$  surfaces can be written as,

$$q_i'' = \sigma \varepsilon_i \sum_{j=1}^{N_e} T_j^4 (\delta_{ij} - D_{ij}) \quad (W/m^2) \quad (3)$$

Where  $\varepsilon_i$ ,  $A_i$ , and  $T_i$  are emissivity, surface area and temperature of the surface  $i$ , respectively.  $\sigma$  is Stefan-Boltzman constant and  $D_{ij}$  is the RDF. In this equation,  $\delta_{ij}$  is Kronecker delta defined as follows:

$$\delta_{ij} = \begin{cases} 1 & i = j \\ 0 & i \neq j \end{cases} \quad (4)$$

In this study, the MCM is employed to calculate the RDFs. A logic block diagram that appears in Fig. 2 shows the procedure of the MCM to obtain the RDF. In this method, first, a large number of energy parcels, called photons, are emitted from randomly selected points on the surface  $i$  and in randomly uniform directions. Then, these photons are traced through a series of reflections until they are finally absorbed by one of the enclosure surfaces called  $j$ . Subsequently, the RDF ( $D_{ij}$ ) is numerically equal to the ratio of the number of photons absorbed by surfaces  $j$  ( $n_{ij}$ ) to the

total number of photons emitted from surface  $i$  ( $n_i$ ). It can be well estimated using a large amount of emitted photons from surface  $i$ .

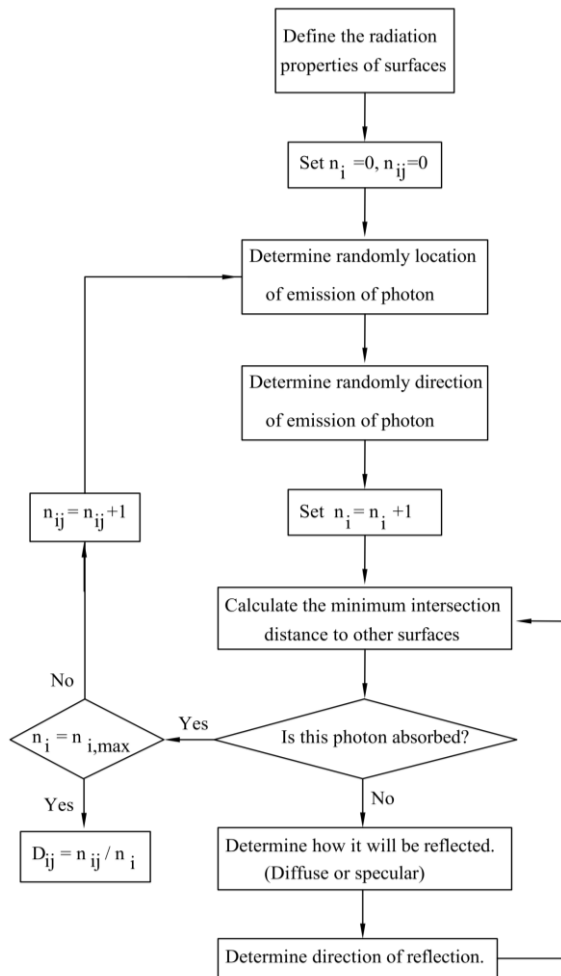

Fig. 2 A logic block diagram for the MCRT method

The accuracy of the RDF results is compared against the results obtained using the radiation shape factor (RSF) approach. The net heat flux of surface  $i$  in an enclosure composed of  $N_e$  surfaces based on the RSF is given by [19]:

$$\sum_{j=1}^{N_e} \left( \frac{\delta_{ij}}{\varepsilon_j} - F_{ij} \frac{1 - \varepsilon_j}{\varepsilon_j} \right) q_j'' = \sum_{j=1}^{N_e} (\delta_{ij} - F_{ij}) \sigma T_j^4, \quad i = 1, 2, \dots, N_e \quad (5)$$

Where  $\delta_{ij}$  is Kronecker delta defined in Eq. (4) and  $F_{ij}$  is RSF between surfaces  $i$  and  $j$ . For this validation study, all surfaces of the furnace and DB are assumed to be diffuse emitters with emissivity values of 0.8 and

0.4, respectively. They are also diffuse-specular reflectors with a specularity ratio of 0.2. With the objective of estimating the heat flux distributions, temperatures of the furnace and DB surfaces are set to 2000°K and 500°K, respectively, and the DB is located at (0.5, 0.5, 0.5). Calculated heat fluxes based on the RDF and RSF formulations have been compared in Fig. 3. An excellent agreement between calculated heat fluxes using the RDF and RSF methods is observed.

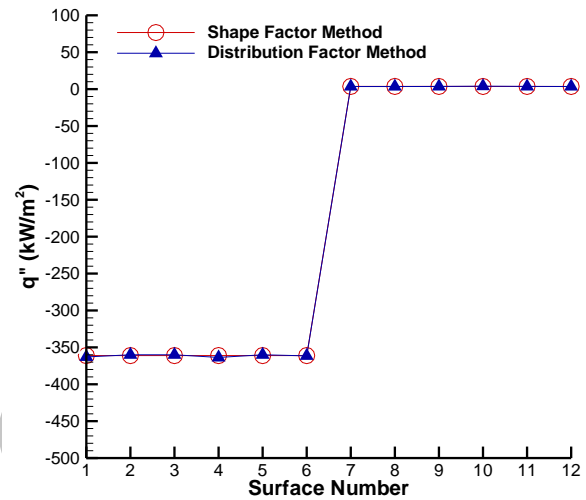

Fig. 3 Comparison of the heat fluxes obtained using the radiation distribution factor method and radiation shape factor method

### 2.3. Optimization based on the genetic algorithm

The GA is a search technique that is based on the principles of the natural selection and survival of the fittest individuals in the nature. Here, a real-valued GA [20] is used as an optimization tool shown in Fig. 4. Finding a global optimum and speed of convergence are greatly influenced by the choices of GA parameters including population size, crossover and mutation ratio [15]. In this optimization problem, to achieve the optimum values, several settings of the GA parameters are tried. Initially, the process of the optimization starts with generating randomly an initial population in appropriate intervals of the optimization variables. Here, 100 individuals are considered in the population and each individual has 4 variables.

In GA method, the individuals of the population are reproduced by means of crossover and mutation operators to obtain a new generation. In this study, the probability of crossover has been fixed at 0.8. In order to increase the diversity in the population and prevent the GA from early convergence to a local optimum solution, the mutation operator is used in the GA method. In this study, 20% of the population is chosen to mutate.

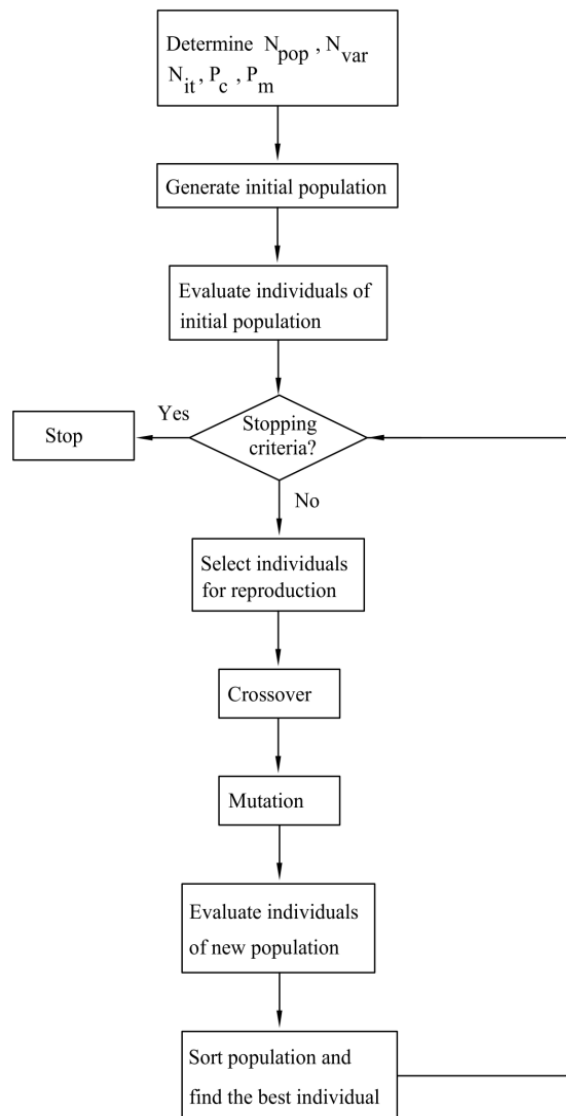

Fig. 4 A flowchart for the genetic algorithm method

In each iteration, objective function values (costs of the individuals) are calculated for all individuals. Then, these values are ranked and the weakest individuals are discarded in order that the average of the cost values decreases in new generation until an acceptable solution is found. The number of generations, that is one of the most commonly used stop criteria, should be defined at the start of the optimization process. The best of the individuals in each generation is chosen until no improvement in the cost values is observed.

### 3 RESULTS AND DISCUSSION

This study aims at optimizing the radiant furnace using the GA and MCM. During the optimization process, the temperature of the heater and the best location of the DB are found to provide a uniform heat flux of 100 kW/m<sup>2</sup> over all surfaces of the DB with specified temperature of 500°K. Prior to presenting the results of the optimization problem, first the effects of the design parameters on the heat fluxes over the DB surfaces are discussed. For this purpose, the heat fluxes over the DB surfaces at 18 locations demonstrated in Table 1 are calculated and the results are illustrated in Fig. 5.

To study the effect of the DB location on the calculated heat flux, the temperature of heater is set to 4000 °K. It can be observed from Fig. 5 that while the temperature of the heater is constant, heat fluxes on the DB surfaces vary with changing the location of the DB. It can also be understood from Fig. 5 that the uniform thermal conditions on the DB surfaces need careful selection of the design parameters including the temperature of the heater and location of the DB inside the furnace. To have a better idea of how the location of the DB influence the heat fluxes over the DB surfaces, the average heat fluxes on all surfaces of the DB in each location are illustrated in Fig. 6. In this investigation, heater temperature is set to 4000 °K. As it can be observed from Fig. 6, with changing the location of the DB, the average heat fluxes over the DB surfaces changes.

Fig. 7 shows the effect of the heater temperature on the objective function values for the DB located at (0.5, 0.5, 0.5). It is clearly evident from Fig. 7 that as the temperature of the heater increases, the objective function value decreases until it reaches its minimum value. Then the objective function value begins to rise with any further increase in temperature. In order to evaluate how the location of the DB affects the objective function values, heat fluxes on the DB surfaces and accordingly the objective function values are obtained at 18 locations and the results are shown in Fig. 8 in one quadrant of the furnace. In this Figure, heater temperature is set to 4000 °K. As it can be observed from Fig. 8, the objective function values vary with changing the location of the DB. Based on the above mentioned studies, we come to the conclusion that for providing the uniform thermal conditions over all surfaces of the 3-D DB in the 3-D radiant furnace, temperature of the heater and location of the DB must be chosen appropriately through an optimization process.

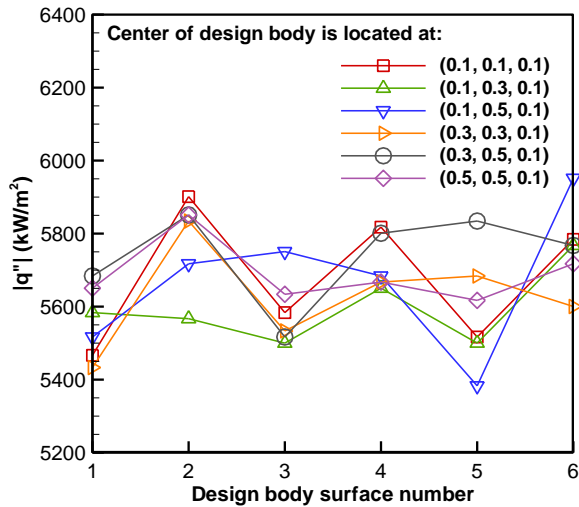

(a) Z=0.1 m

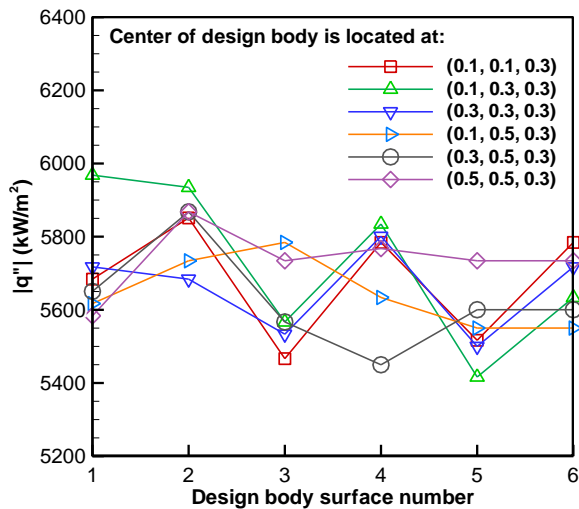

(b) Z=0.3 m

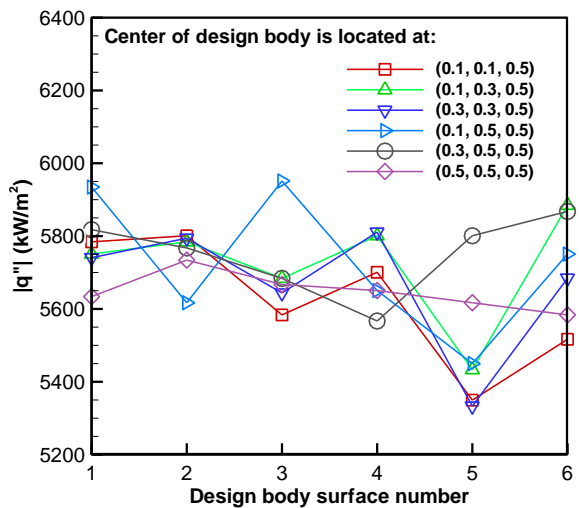

(c) Z=0.5 m

Fig. 5 Calculated heat fluxes over the design body surfaces at 18 locations (Temperature of the heater is set to 4000°K)

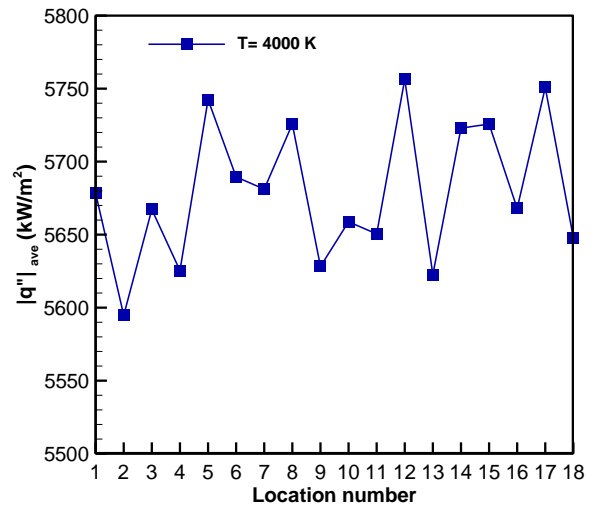

Fig. 6 The average heat fluxes on the design body surfaces at 18 locations (Heater temperature is set to 4000°K)

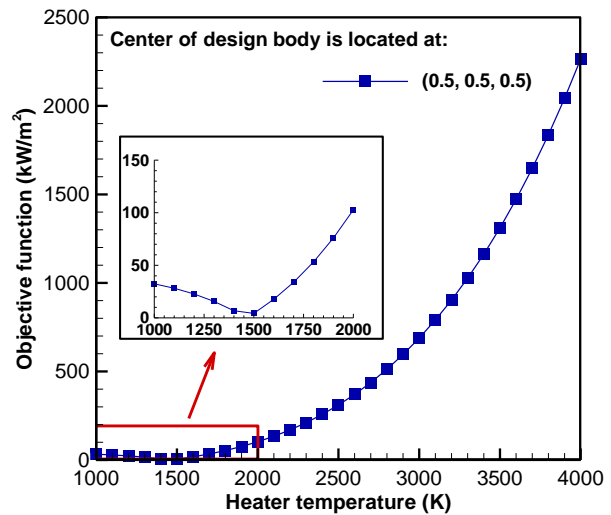
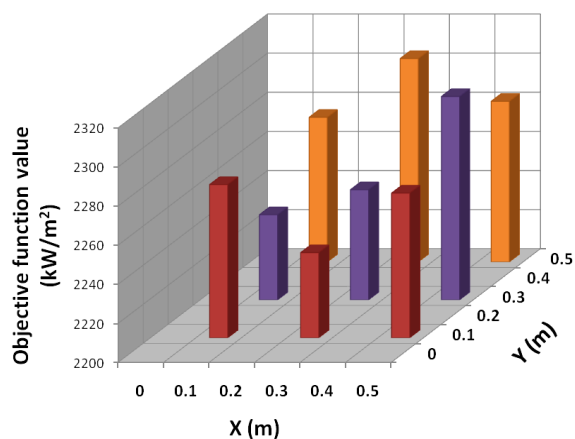

Fig. 7 Effect of the heater temperature on the objective function values when the design body is located at (0.5, 0.5, 0.5)

Optimal results are listed in Table 2. The heat flux distribution on the DB surfaces at the optimal point is presented in Fig. 9. It can be seen that the calculated heat fluxes at the optimal point are well close to the desired one (100 kW/m<sup>2</sup>) with an acceptable uniformity and a variance of 0.09 kW/m<sup>2</sup>.

Table 2 Optimal values of the design parameters

Design parameters	$x_c$ (m)	$y_c$ (m)	$z_c$ (m)	$T_H$ (K)
Optimal value	0.1	0.1	0.1	1464



(a) Z=0.1 m

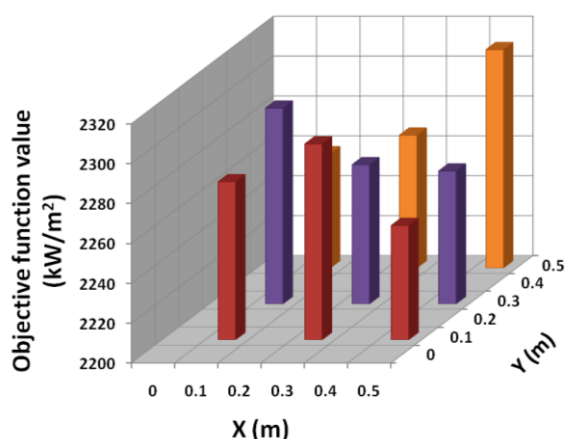

(b) Z=0.3 m

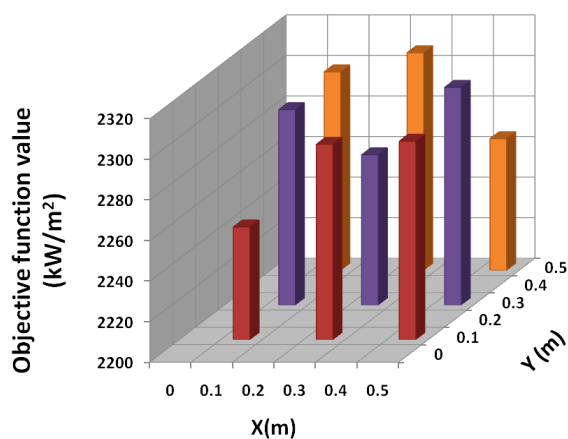

(c) Z=0.5 m

Fig. 8 The objective function values in one quadrant of the furnace (Temperature of the heater is set to 4000°K).

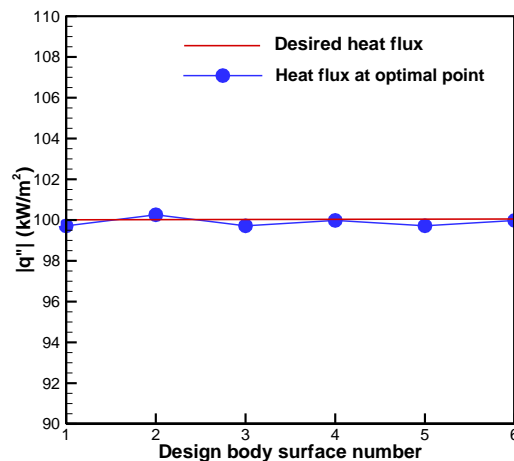

Fig. 9 Heat flux distribution on the DB surfaces at the optimal point

In order to clarify the obtained results, Fig. 10 shows the heat fluxes over the top and bottom surfaces of the DB at the first 6 locations presented in Table 1 (Z=0.1 m) when temperature of the heater is set to optimum temperature ( $T_H=1464^{\circ}K$ ). As it can be observed, when the DB moves from center to the corner of the furnace, the heat flux on bottom surface increases and it decreases on the top surface of the DB. Consequently, the objective function value decreases until it reaches to the minimum point. So, the difference between the heat fluxes over bottom and top surfaces and objective function value are minimum at (0.1, 0.1, 0.1).

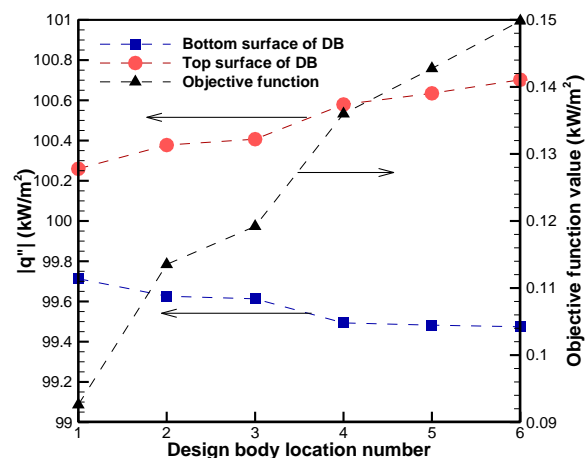

Fig. 10 Calculated heat fluxes over the top and bottom surfaces of DB at 6 locations (Z= 0.1m) when the heater temperature is set to optimum temperature ( $T_H=1464^{\circ}K$ )



#### 4 CONCLUSION

This study demonstrates the successful application of combination of the MCM and GA for design and optimization of the 3-D radiant furnaces to satisfy the uniform thermal conditions on the surfaces of the 3-D DBs. Effects of different parameters including the heater temperature and location of the DB on achieving the uniform thermal conditions on the DB surfaces were investigated. It was shown that while the temperature of the heater is constant, heat fluxes over the DB surfaces vary with changing the location of the DB. Hence, the GA was used in conjunction with the MCM to find the optimal location for the DB as well as the temperature of the heater to satisfy the uniform heat flux and temperature distributions on the DB surfaces. Results showed that the calculated heat fluxes on the DB surfaces are in good agreement with the desired one. It was concluded that the GA-MCM is an efficient combined method to optimize the 3-D radiant furnaces which can be used by designers to find a prior knowledge about the suitable temperature of the heater and the optimal location of a product to provide the uniform thermal conditions on its surfaces.

#### 5 NOMENCLATURE

$D_{ij}$	Radiation distribution factor between surfaces $i$ and $j$
$F_{ij}$	Radiation shape factor between surfaces $i$ and $j$
$F$	Objective function
$N_d$	Number of design body surfaces
$N_e$	Number of enclosure surfaces
$q_d$	Heat Flux over design surfaces
$q_c$	Calculated heat fluxes
$T_H$	Temperature of heater
Greek symbols	
$\sigma$	Stefan-Boltzman constant
$\varepsilon_i$	Emissivity of surface $i$
$\delta_{ij}$	Kronecker delta

#### REFERENCES

- [1] Erturk, H., Ezekoye, O. A., and Howell, J. R., "Comparison of three regularized solution techniques in a three-dimensional inverse radiation problem", *J. Quant. Spectrosc. Radiat. Transfer*, Vol. 73, 2002, pp. 307-316.
- [2] Daun, K., França, F., Larsen, M., Leduc, G., and Howell, J. R., "Comparison of methods for inverse design of radiant enclosures", *J. Heat Transfer*, Vol. 128, 2005, pp. 269-282.
- [3] Liu, D., Wang, F., Yan, J. H., Huang, Q. X., Chi, Y., and Cen, K. F., "Inverse radiation problem of temperature field in three-dimensional rectangular Enclosure containing inhomogeneous, anisotropically scattering media", *Int. J. Heat Mass Transfer*, Vol. 51, 2008, pp. 3434-3441.
- [4] Bayat, N., Mehraban, S., and Sarvari, S. M., "Inverse boundary design of a radiant furnace with diffuse-spectral design", *Int. Commun. Heat Mass Transfer*, Vol. 37, 2010, pp. 103-110.
- [5] Lee, K. H., Beak, S. W., and Kim, K. W., "Inverse radiation analysis using repulsive particle swarm optimization algorithm", *Int. J. Heat Mass Transfer*, Vol. 51, 2008, pp. 2772-2783.
- [6] Safavinejad, A., Mansouri, S. H., Sakurai, A., and Maruyama, S., "Optimal number and location of heaters in 2-D radiant enclosures composed of specular and diffuse surfaces using micro-genetic algorithm", *Appl. Therm. Eng.*, Vol. 29, 2009, pp. 1075-1085.
- [7] Safavinejad, A., Mansouri, S. H., and Hosseini Sarvari, S. M., "Inverse boundary design of 2-D radiant enclosures with absorbing-emitting media using micro-genetic algorithm", *IASME Transaction*, Vol. 2, 2005, pp. 1558-1567.
- [8] Chopade, R. P., Mishra, S. C., Mahanta, P., Maruyama, S., and Komiya, A., "Uniform thermal conditions on 3-D objects: Optimal power estimation of panel heaters in a 3-D radiant enclosure", *Int. J. Therm. Sci.*, Vol. 51, 2012, pp. 63-76.
- [9] Chopade, R. P., Mishra, S. C., Mahanta, P., and Maruyama, S., "Estimation of power of heaters in a radiant furnace for uniform thermal conditions on 3-D irregular shaped objects", *Int. J. Heat Mass Transfer*, Vol. 55, 2012, pp. 4340-4351.
- [10] Liu, F. B., "An application of particle swarm optimization to identify the temperature-dependent heat capacity", *Heat and Mass Transfer*, Vol. 48, 2012, pp. 99-107.
- [11] Sencan Sahin, A., Kılıc, B., and Kılıc, U., "Optimization of heat pump using fuzzy logic and genetic algorithm", *Heat and Mass Transfer*, Vol. 47, 2011, pp. 1553-1560.
- [12] Moparthy, A., Das, R., Uppaluri, R., and Mishra, S. C., "Optimization of Heat Fluxes on the Heater and the Design Surfaces of a Radiating-Conducting Medium", *Numerical Heat Transfer, Part A*, Vol. 56, 2009, pp. 846-860.
- [13] Chopade, R. P., Mishra, S. C., Mahanta, P., Maruyama, S., Numerical Analysis of an Inverse Boundary Design Problem of a 3-D Radiant Furnace with a 3-D Design Object", *Numerical Heat Transfer, A*, Vol. 60, 2011, pp. 25-49.
- [14] Amiri, H., Mansouri, H., and Coelho, P. J., Inverse Optimal Design of Radiant Enclosures with Participating Media: A Parametric Study, *Heat Transfer Engineering*, Vol. 34, No. 4, pp. 288-302, 2013.
- [15] Gosselin, L., Tye-Gingras, M., and Mathieu-Potvin, F., "Review of utilization of genetic algorithms in

- heat transfer problems, International Journal of Heat and Mass Transfer, Vol. 52, 2009, pp. 2169-2188.
- [16] Howell, J. R., "The Monte Carlo method in radiative heat transfer", J. Heat Transfer, Vol. 120, 1998, pp. 547-560.
- [17] Modest, M. F., "Radiative Heat Transfer", second ed., Academic Press, USA, 2003, pp. 644-676.
- [18] Mahan, J. R., "Radiation Heat Transfer-A Statistical Approach", John Wiley & Sons, New York, 2002, pp.305-333.
- [19] Siegel, R., Howell, J. G., "Thermal Radiation Heat Transfer", fourth ed., McGraw-Hill, New York, 1972, pp. 207-248.
- [20] Haupt, S. E., Haupt, R. L., "Practical genetic algorithm", second ed., pp. 51-65, John Wiley, New Jersey, 2004.

Archive of SID