



The Structural Behaviour of Lightweight Composite Trusses in Fire during The Event of World Trade Centre

Choi, S., Burgess, I., & Plank, R. (2003). The Structural Behaviour of Lightweight Composite Trusses in Fire during The Event of World Trade Centre. In *SFPE/ASCE Specialty Conference: Designing Structures for Fire*

[Link to publication record in Ulster University Research Portal](#)

Published in:
SFPE/ASCE Specialty Conference: Designing Structures for Fire

Publication Status:
Published (in print/issue): 01/10/2003

Document Version
Author Accepted version

General rights
Copyright for the publications made accessible via Ulster University's Research Portal is retained by the author(s) and / or other copyright owners and it is a condition of accessing these publications that users recognise and abide by the legal requirements associated with these rights.

Take down policy
The Research Portal is Ulster University's institutional repository that provides access to Ulster's research outputs. Every effort has been made to ensure that content in the Research Portal does not infringe any person's rights, or applicable UK laws. If you discover content in the Research Portal that you believe breaches copyright or violates any law, please contact pure-support@ulster.ac.uk.

The Structural Behaviour of Lightweight Composite Trusses in Fire during The Event of World Trade Centre

SENG-KWAN CHOI¹, IAN BURGESS^{1*} AND ROGER PLANK²

*¹Department of Civil and Structural Engineering, University of Sheffield,
Mappin Street, Sheffield S1 3JD, UK*

*²School of Architecture, University of Sheffield, Western Bank,
Sheffield S10 2TN, UK*

ABSTRACT: On September 11 2001, the twin towers of World Trade Centre were struck by two hijacked airplanes. Despite severe local damage induced by the impact, the towers were able to sustain 103 and 56 minutes of the subsequent fire. The purpose of this study is to contribute to the understanding of the behaviour of WTC 1 tower, during the events, in structural fire engineering terms. Using FE package VULCAN, the structural mechanism of the typical long-span composite floor trusses in fire is explained under a variety of scenarios, varying boundary condition, degree of protection and loading. The results are presented as graphs of deflections against time.

KEY WORDS: composite truss, catenary action, numerical modelling, progressive collapse, structural fire engineering, world trade centre

INTRODUCTION

The event of WTC 1 was initiated at 8:45 am on September 11 2001, by the strike of a hijacked American Airlines Flight 11 (Boeing 767-200ER) to the north face of the tower between the 94th and 98th floors. Significant damage to partition walls in the occupancy floor and partial collapse of frames in the core were reported by people who were a couple of floors below of the impacted area [1]. Part of the floors (one-way long span), supported by approximately 30 destroyed external columns in the impact range, may have fallen down. Some debris from the plane, which penetrated through the building, was found in nearby places. At 9:06 am, another hijacked United Airlines Flight 175 (Boeing 767-200ER) struck on a skewed angle toward the south face of WTC 2 between 78th to 84th floors. A similar pattern of structural damage may have been caused to frame, core and floors (one-way short span and two-way corner) of the tower due to the impact.

Immediately after the plane crashes to WTC 2, it was observed that large scale fireballs, forming from the dispersion of the jet fuel from the plane, emanated through broken

*Authors to whom corresponding should be addressed. E-mail:i.burgess@sheffield.ac.uk

windows and frames from three sides of the impact area in the tower. These fireballs are believed to ignite very severe fires over the combustible surfaces during a short period. Accompanying smoke was observed to be generated from these areas. However, no explosion was reported during the period of fire. Less information regarding initial fire in WTC 1 is available, but it is believed to be alike. Despite the massive structural damage and localised collapse, the highly redundant structures of the twin towers maintained their integrity through load redistribution, as the towers were known to be originally designed against the impact of Boeing 707 [2], and successfully sustained the ensuing fire for 103 and 56 minutes.

This study was organized to contribute to understand the fire performance of WTC 1 during the event. Unlike a typical fire study for a compartment situation, this case contains many uncertainties such as the detail damage of the airplane impact to the floor structure, the fire proofing material, the compartments, and the large scale fire situation, spreading simultaneously to a couple of floors. Therefore, regarding various rational assumptions to simulate extreme situations during the event, the study was numerically conducted to investigate the detail mechanism of the composite truss during the event.

MODELLING

WTC 1&2 were 110-storey steel frame buildings, each having a square floor of approximately 3980m^2 ($63.7\text{m}\times 63.7\text{m}$). The perimeter of the buildings consisted of 356mm square steel box columns, spaced at 1m centres, which were linked at each floor level by a 1.3m deep spandrel plate. Various strength of material and thickness were used for the perimeter columns, dependent on location. The central core ($26.2\text{m}\times 42.3\text{m}$) of the buildings comprised of larger box or wide flange sections of columns, at a greater spacing, with lightweight drywall panels for partitioning. Elevators, escalators, emergency stairway and services were housed in the core. A typical occupancy floor, composed from one-way long (18.3m) span, one-way short (10.7m) span and two-way ($18.3\text{m}\times 10.7\text{m}$) corner areas, was designed using composite trusses, spanning from the core section to alternative perimeter columns of the building.

In the long span area, which is the immediate area of impact in WTC 1, a dual composite truss, 18.3m length, 2.0m spacing and 752.8mm depth, with a concrete slab and profiled metal decking was used. The vertical floor-to-floor spacing was 3.7m. Double angles of L 50.8mm \times 38.1mm \times 6.4mm (A50) and L 76.2mm \times 50.8mm \times 9.4mm (A36) were selected for the top and bottom chords. A solid round bar of $\phi 29.0\text{mm}$ (A50) was used for the first web member. The remaining webs comprised a solid round bar of $\phi 27.7\text{mm}$ (A46). The steel decking was placed underneath the lightweight concrete ($20.7\text{N}/\text{mm}^2$) of 101.3mm topping and 38.1mm rib. The top chord, locally stiffened, was connected to the external and core columns by means of a steel angle (coupled using two 15.9mm bolts), with a welded

gusset plate and channel respectively. The bottom chord was also linked to the external columns via a damper, which reduced the lateral sway of the tower under wind.

For this study, a symmetric half of the composite truss was numerically modelled with and without a supporting column (Fig 1). In the case of the composite truss, which includes the column, a pinned beam-to-column connection was inserted. For the isolated truss case, a simple support was used as the end boundary condition. The connection between the bottom chord and the external column was ignored due to the fact that there was no application of fire protection to the part. The proposed model was designed assuming continuous bottom chord & top chord with the LWC slab excluding the steel decking. The pin-ended webs are connected between the centroid of the top and bottom chords. No eccentricity was regarded at the connections. The geometry was assumed to be such that no local damage was induced due to the collision of the airplane.

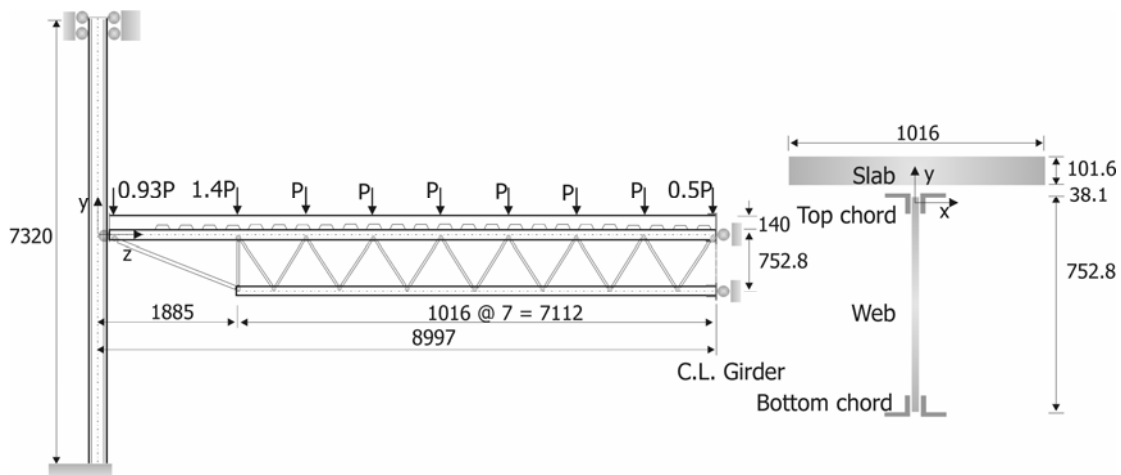

Figure 1 Layout of the composite truss (dimensions in mm)

Two types of loading, a design load at fire limit state and an arbitrarily assumed load for the real situation, were regarded. The loading at the fire limit state of 4.8kN/m^2 was calculated, according to BS5950:Pt8 [3] and BS6399: Pt1 [4], using the characteristic loads of dead load, 2.8kN/m^2 (58.0psf), and live load, 3.4kN/m^2 (70.0psf). The arbitrarily assumed load, a combination of the full dead load and a third of live load, was 3.9kN/m^2 . The assumption of the live load reduction is from that the weight of the fire load reduces by 80 to 30% when the fire is over the fully developed period [5]. All transverse loading was applied at the connections of the top chord and bracing members.

TEMPERATURE ASSESSMENT

A FEMA report [1] estimated that approximately 4000 gallons of airplane fuel may have remained on the impacted floors of WTC. If this is assumed to be evenly distributed over five damaged floors in WTC 1, the increase of the fire load due to the fuel may not have

been significantly different from a generic fire load in an office [6]. However, the aerosol type of jet fuel is believed to contribute spontaneous spread of fire to combustible surfaces over the floors at a yearly stage of the fire. The opening factor, dependent on the aircraft impact damage, varies between floors but was still relatively low due to the large ratio of floor area to storey height. Therefore, a ISO834 fire [7] was adapted to assess a temperature development of the composite truss. The influence of active sprinkler protection system was not included since this was almost certainly inactive or ineffective. The long-span composite trusses in the twin towers was designed to be insulated under normal conditions to resist two hours of the standard fire by a prescriptive method [8]. Due to the airplane impact and blast, very little of the extremely fragile sprayed insulation material would have remained intact on the sprayed surface of many trusses. Hence, this study regarded fully protected/unprotected composite trusses to represent the reasonable upper and lower bound cases of the situation. The column was assumed to be protected under both of the cases.

In the unprotected case, the temperature development of each of the chords (Fig 2) was calculated upon the section factor, A/V , using a formula provided by Eurocode4: Pt1.2 [9]. The temperature increase, $\Delta\theta_a$, of unprotected steel chords during the time interval, Δt , may be determined by following formula:

$$\Delta\theta_a = \frac{\alpha_c + \alpha_r}{C_a \rho_a} \cdot \frac{A}{V} \cdot (\theta_t - \theta_a) \cdot \Delta t \quad (1)$$

where the coefficient of radiative heat transfer, α_r , is given by:

$$\alpha_r = \Phi \left(\frac{5.67 \times 10^{-8} \epsilon_{res}}{\theta_t - \theta_a} \right) \left((\theta_t + 273)^4 - (\theta_a + 273)^4 \right) \quad (2)$$

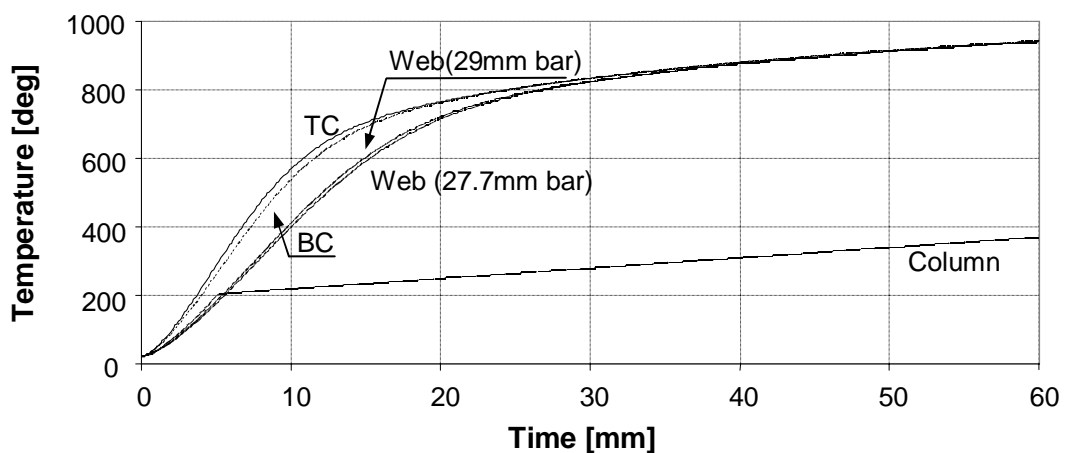

Figure 2 Temperature development of unprotected chord members in the standard fire

As for the protected truss, the temperature development of the protected chord members was assumed to increase to about 200°C in a similar fashion to the unprotected members, and then to progress linearly up to 620°C at 120 minutes for top and bottom chord and 550°C for web. The design temperature of the column was 550°C at 120 minutes.

A thermal analysis (Fig 3) was conducted, using heat transfer software [10], to generate the temperature development of the LWC slab topping, divided into 9 layers with the steel decking, in the standard fire. The moisture content was taken to be 2% of the concrete weight and coefficients of heat transfer were chosen from generic data given by Purkiss [11].

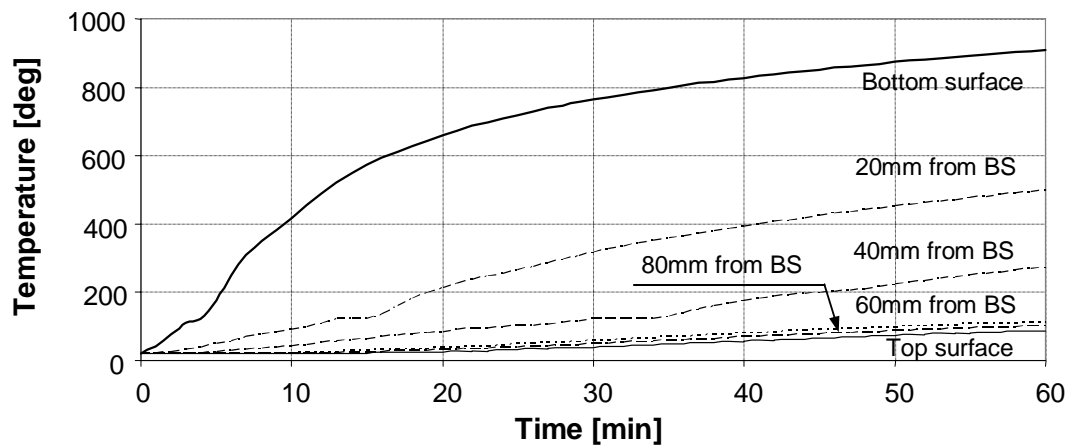

Figure 3 Temperature development of 100mm topping of LWC slab in the standard fire

MATERIAL PROPERTIES AT ELEVATED TEMPERATURES

The performance of concrete and steel at elevated temperatures varies inelastically with temperature-dependent characteristics such as strength, stiffness, thermal expansion, specific heat and thermal conductivity. For numerical analyses, the thermal characteristics of the materials were formulated in accordance with Eurocode3:Pt1.2 [12] and Eurocode 4:Pt1.2 [9].

The stress-strain relationship of the steel, at elevated temperatures, is determined, as shown in Figure 4. A set of linear-elliptical curves, excluding a strain hardening, illustrates that the yielding initiates from 2% strain limit at any temperature and the ultimate strain is defined at 20% strain limit. It is assumed to be identical under both of the stress condition, compression and tension. The constitutive model contains the unloading path, including the plastic strain. It is noted that the steel begins to lose significant amount of the strength, of 2% strain limit, at temperature above 400°C and approximately 11% of the strength remains at 800°C. It defines the yield stress to be zero at 1200°C for design purposes.

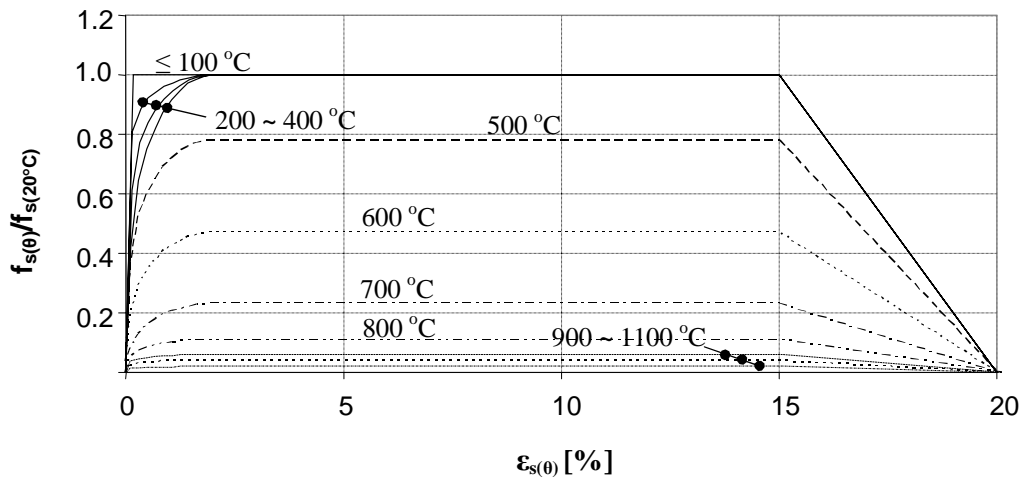

Figure 4 Stress-strain relationship of steel at elevated temperatures

Due to the heterogeneous nature of concrete, such as a mixture of cement paste, mortar, aggregate, small quantities of additions, various forms of water and pores, it is difficult to establish accurate temperature-dependent characteristics. The stress-strain relationship of light-weight concrete in compression at elevated temperatures, used for this study, is shown in Figure 5. The light-weight concrete has lower decrease of strength and stiffness at elevated temperatures, due to the low thermal conductivity of lightweight aggregate compared to normal concrete [13]. The tensile strength of the concrete at elevated temperatures is taken into account by adapting a tensile stress-strain curve, proposed by Rots et al.[14] and tested by Hunag[15] & Jun[16]. The curve, as shown Figure 6, is modelled to have an linear behaviour to the peak tensile strength, $f_t(\theta)=0.3321\sqrt{f_c(\theta)}$ [17], which does not exceed 10% of corresponding compressive stress suggested by Eurocode4:Pt1.2 [9]. Then, a bilinear curve for tensile strain-softening after cracking [18], upto the maximum tensile strain, $\epsilon_{ct}(\theta)=15f_t(\theta)/E_c(\theta)$. After cracking under tension, the concrete is still able to carry compression, but when crushing under compression, it is ignored.

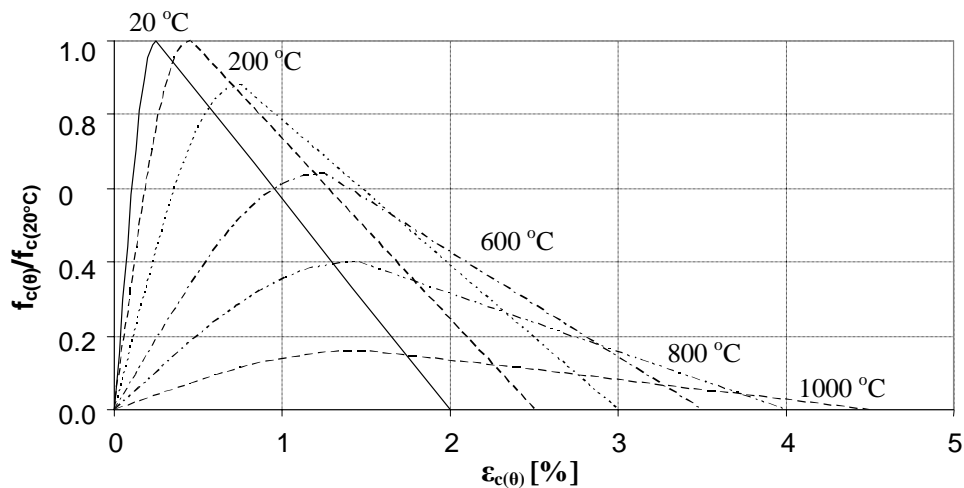

Figure 5 Stress-strain relationship of concrete in compression at elevated temperatures

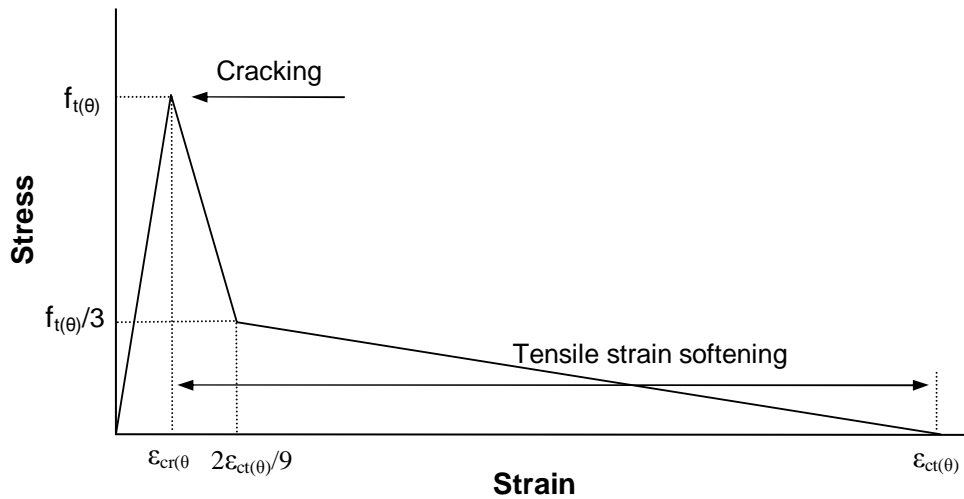

Figure 6 Stress-strain relationship of concrete in tension at elevated temperatures

PARAMETRIC STUDIES

The numerical analyses for the structural behaviour of the long span floor system of WTC 1 in fire is conducted by using the finite element program, VULCAN, which has been specifically developed at the structural fire engineering group in the University of Sheffield [19-24] on the purpose to investigate the structural performance at elevated temperatures. The composite truss was modelled by using two and three noded 3D beam-column elements, which allows the cross section to contain as many segments, allocated to steel, concrete or dummy, as needed to be accurate, so possible to model any shape and material conditions. The Newton-Raphson technique is employed for the solution procedure to obtain the load-deformation characteristics of the structures at each temperature or load increment.

The unrestrained composite truss

During the event of WTC 1, it was observed that a significant number of the external columns were damaged due to the crash and several floors were simultaneously exposed to a fire caused by the widely-spread jet fuel. In this situation, the top and bottom floors in this area might still retain horizontal restraint, provided by the supporting column, as with a compartment fire model. However, it is likely that the horizontal thrust, in the middle floors, may be far less restrained in this direction. In order to understand the behaviour of the middle floors in fire, a simply supported composite truss, with and without protection, was numerically analyzed, using VULCAN for 60 minutes of the standard fire, under loadings of 4.8kN/m^2 at fire limit state and 3.9kN/m^2 at arbitrary condition.

The equilibrium condition of the composite truss at ambient temperature is illustrated in Figure 7. Double black and white arrows indicate compression and tension respectively. Single black vertical arrows represent resultant shear forces. The critical elements of the

model can be identified at ambient temperature by examining the load ratios in the members. The peak value of load ratio under tension occurs in the mid-span member of the bottom chord, 8.5-9.0m from the support. For compression it is the second compressive web, which is the fourth web member from the support.

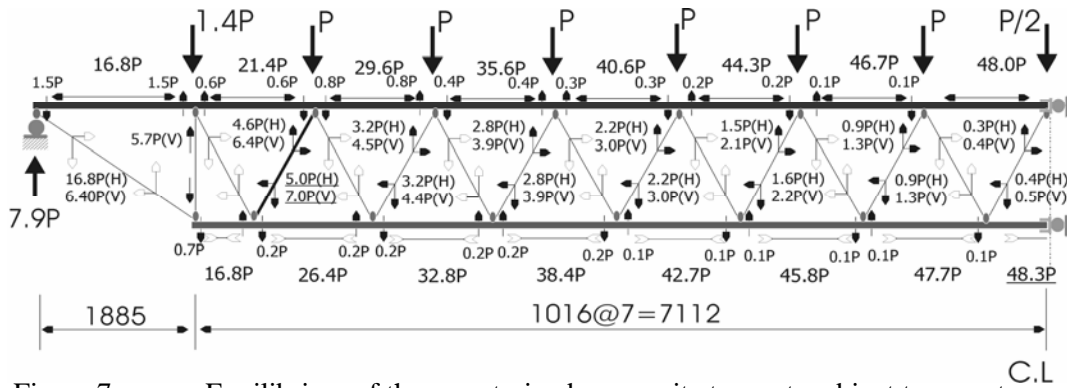

Figure 7 Equilibrium of the unrestrained composite truss at ambient temperature

The numerical analyses of the protected and unprotected composite truss are shown as a vertical deflection against time in Figure 8. The protected composite truss, under the loadings, 4.8kN/m^2 and 3.9kN/m^2 , deflects approximately $L/100$ and $L/150$ at 60 minutes of the standard fire. During the period, the flexural mechanism of the protected model is maintained without any local instability. The unprotected trusses resist up to 12.5 and 13.4 minutes, at which time the second compressive web buckles due to the rapid temperature increment of the unprotected webs at early stage of the resistance period. The local instability initiates the failure of the flexural mechanism of the model. Hence, the protection condition of critical web elements is the sensitive factor under the considered level of the loads, in terms of the structural resistance in the standard fire regarding simply-supported models. The unprotected condition can represent any kind of the structural damage in this case. Details of a similar pattern in the structural mechanism of a composite truss in fire were shown for more general configuration of the composite trusses [25].

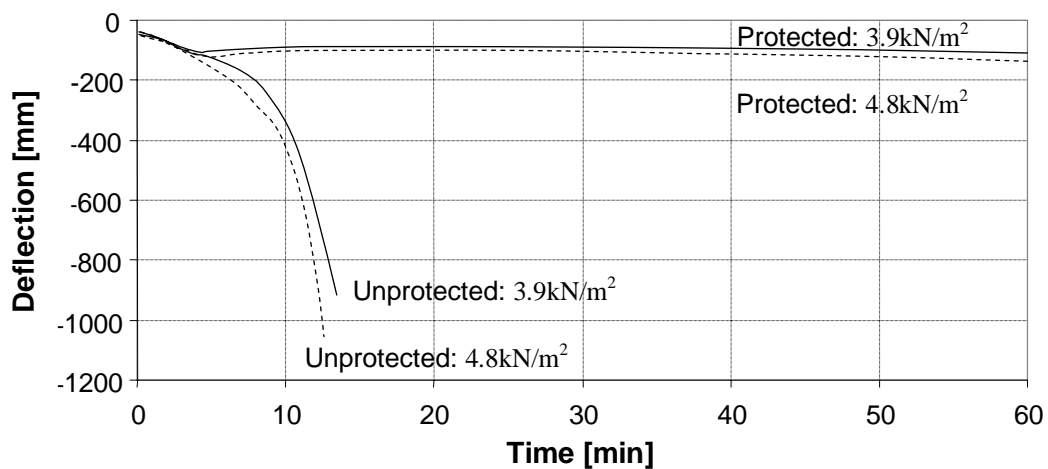

Figure 8 Vertical deflection of the mid-span of the top chord in the standard fire

The composite truss with a supporting column

To simulate the top and bottom floors in the fire-exposed levels or floors in localized compartment fire, the structural behaviour of protected and unprotected composite trusses with a supporting column, for 60 minutes of the standard fire, was numerically investigated using VULCAN under both of the loadings, 4.8kN/m^2 and 3.9kN/m^2 . The performance of the models is shown, in Figure 9, in terms of the vertical deflection of the mid-span top chord against time. In order to present the contribution of the supporting column to the behaviour of the composite truss in fire, the variation of the horizontal reaction at the beam-column connection, under the arbitrary loading, is plotted in Figure 10.

Figure 9 shows that the protected models resist 60 minutes of the standard fire with deflection of about $L/90$. During this period, the flexural mechanism was maintained (Fig. 11(a)) as that of unrestrained condition. Hence, the column consistently experiences a push-out force (Fig. 10) due to the thermal elongation of the slab and top chord.

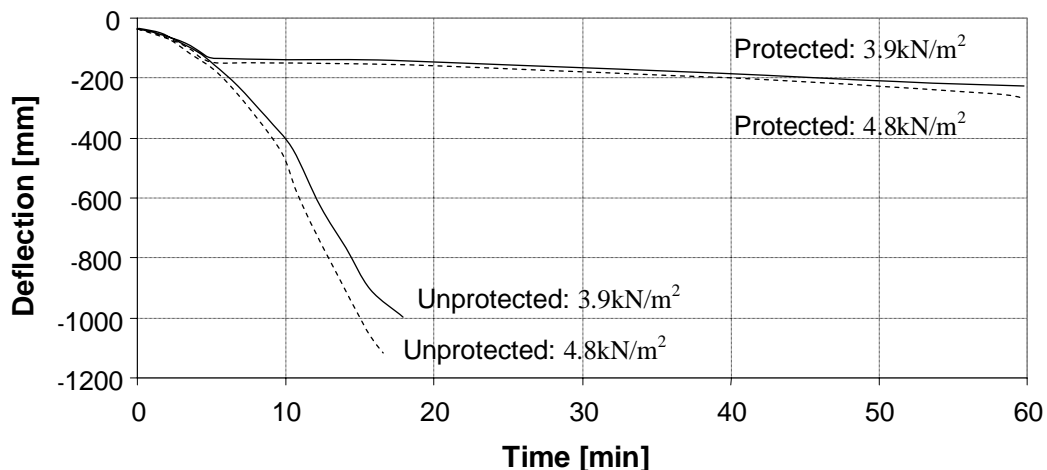

Figure 9 Vertical deflection at the mid-span of the top chord in the standard fire.

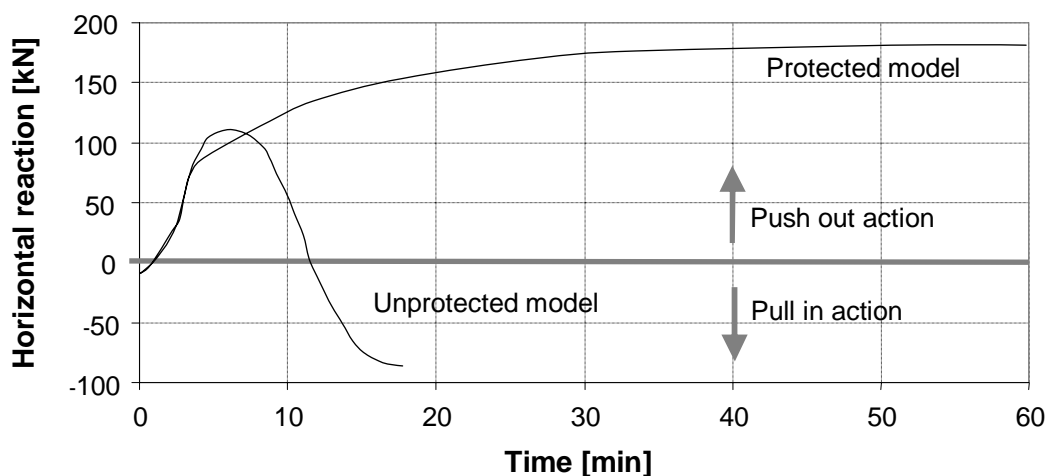

Figure 10 Horizontal reaction at the beam-column connection under estimated loading in the standard fire.

The unprotected models under 4.8kN/m^2 and 3.9kN/m^2 are shown in Figure 9 to have their first local instability at 16.1 and 18.0 minutes of the standard fire. The second compressive web, which was demonstrated to contain the highest compressive load-ratio in the simply supported condition, was the first to buckle (Fig. 11(b)). Through a load redistribution process, the compressive web with the next highest load-ratio was observed to buckle progressively at the same time. Eventually, the series of progressive local instabilities caused the remaining part of the composite truss to collapse via tension of the slab and top chord (Fig. 11(c)). Regarding the reaction of the beam-column connection, it can be seen in Figure 10 that the horizontal reaction changed from outward to inward direction at 11.7 minutes of the standard fire. This occurred because the flexural capacity of the composite truss reduces significantly due to the temperature increase of the unprotected bottom chord. It can be noticed that, at 11.7 minutes, the temperature of the member reaches approximately 600 degrees, at which the strength retention of 2% strain limit for tension members is 42% [12]. Afterward, the yielding starts in a spreading motion from the mid-span to the remaining

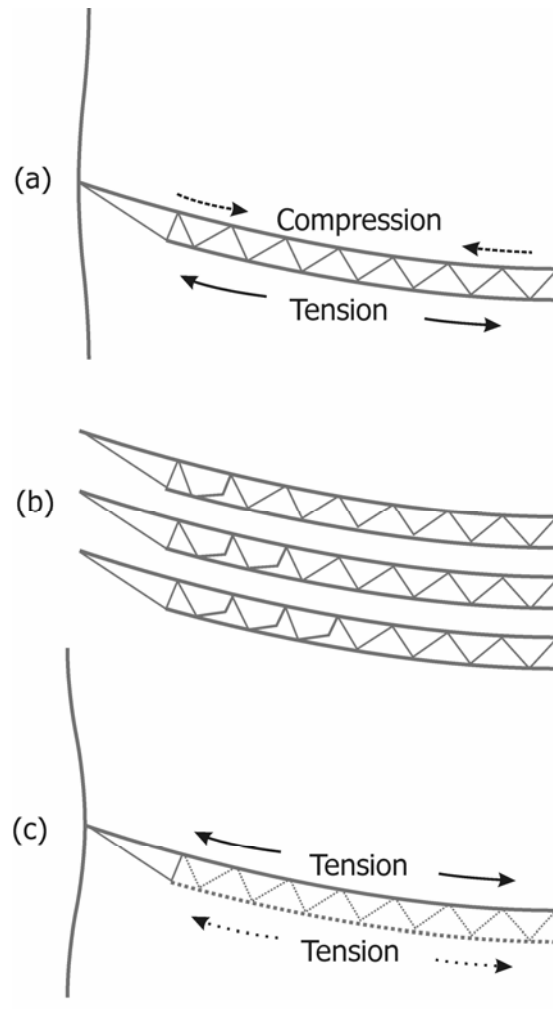

Figure 11 Structural mechanism of the composite truss in fire: (a) in bending; (b) as diagonals buckle; (c) in full catenary action

members in the bottom chord. Once this condition occurs, the moment resistance of the composite truss, generated by the lever arm between top and bottom chords, ceases to be valid. Therefore, the mechanism of the composite truss is transformed such that the slab and top chord to carry the imposed load in tension rather (Fig. 11(c)) than compression (Fig. 11(a)). This phenomenon is called 'catenary action'. The structural advantage, generated by the catenary action of the composite truss with respect to the fire resistance, might not be fully utilized in this unprotected model due to the simultaneous local instabilities.

The analyses showed that the fire performance of the protected and unprotected composite trusses is not very sensitive in relation to the considered loads, in terms of the deflection and resistance period respectively. In the realistic situation of various patterns of partially protected composite trusses, the load may be a much more sensitive factor in the

resistance period. Further, in case that additional reinforcement were included in the slab, which is not known in detail, it may be possible for the slab and top chord to sustain using the catenary action for a certain period, after the progressive collapse of the webs. It was observed that a sudden massive change in the horizontal reaction force may be induced at the beam-column connection during the process of the progressive collapse for the unprotected model. It is questionable whether or not the connection, subject to fire, was able to tolerate the significant force change in the real case.

CONCLUSION

During the events of September 11 2001, the twin towers maintained their integrity through load redistribution after undergoing structural damages due to the airplane impact, as specified in their original design. However, under the conditions of the ensuing fire, the buildings subsequently collapsed. This study was aimed at understanding the fire performance of the floor system employed, in terms of the effects of passive protection, support conditions and loading.

With respect to the passive protection, 2-hour protected and unprotected cases were considered. In the unprotected situation, temperatures in the individual truss elements were calculated using the incremental method described in Eurocode4: Part 1.2 [9] accounting for the section factor. The corresponding temperatures in the slab were obtained from a thermal analysis. For the protected case, the temperature rise of trusses was assumed to increase to 200°C as with the unprotected case and develop linearly to 550°C for the webs and 620°C for the chords at 120 minutes.

Numerical analyses, using VULCAN, of the composite trusses with and without accounting for the restraint provided by a supporting column, simply representing the extreme and the middle floors among the fire exposed levels, up to 60 minutes of the standard fire. The numerical analyses demonstrated that the unrestrained and protected composite truss, under the loadings, 4.8kN/m² and 3.9kN/m², resist 60 minutes of the standard fire within a deflection of L/100. The unprotected simply supported trusses became unstable at 12.5 and 13.4 minutes due to the buckling of the second compressive web. Both of the protected trusses with a supporting column deflect approximately L/90 at 60 minutes of the standard fire without any local instability. The unprotected composite truss was shown to resist 16.1 and 18.0 minutes of the standard fire before the progressive buckling of webs in compression caused a loss of stability. This would undoubtedly have re-stabilised when catenary action of the top chord and slab reinforcement took effect, but their tensile strength, together with tying strength of the beam-column connections, would then become critical. It was found for both types of support condition (with/without column) that the fire resistance for the unprotected truss was relatively insensitive to the level of loading (4.8kN/m² and 3.9kN/m²). The structural or passive protection damage to the high load-carrying element of the composite truss was identified to be crucial to determine the fire performance of the model.

Functions, such as the severity of fire, the loading condition, the influence of the remaining protection pattern and the connection robustness, need to be further investigated to understand the fire performance of the composite truss during the event in WTC.

ACKNOWLEDGMENT

The authors gratefully acknowledge the support of METSEC Building Products Ltd, and the collaboration of Buro Happold FEDRA.

NOMENCLATURE

A	exposed surface area of the steel cross section per unit length (m^2/m)
C_a	specific heat of steel (600 J/kgK)
$E_c(\theta)$	$=1.5 f_c(\theta)/\varepsilon_{cI}(\theta)$
$f_s(\theta)$	strength of steel in fire situation (N/mm^2)
$f_c(\theta)$	compressive strength of concrete in fire situation (N/mm^2)
$f_t(\theta)$	peak tensile strength of concrete in fire situation (N/mm^2)
V	volume of the steel cross section per unit length (m^3/m)

Greek

α_c	coefficient of convective heat transfer ($25\text{W}/\text{m}^2\text{K}$ for cellulosic fires)
α_r	coefficient of radiative heat transfer
$\varepsilon_c(\theta)$	concrete stain
$\varepsilon_{cI}(\theta)$	concrete stain corresponding to $f_c(\theta)$
$\varepsilon_{cT}(\theta)$	concrete stain corresponding to $f_t(\theta)$
ε_{res}	resultant emissivity of the fire compartment and the surface
$\varepsilon_s(\theta)$	steel stain
$\varepsilon_{ult}(\theta)$	maximum tensile strain of concrete in fire situation
θ_t	average gas temperature during the interval Δt ($^{\circ}\text{C}$)
θ_a	steel temperature at the end of the interval Δt ($^{\circ}\text{C}$)
ρ_a	density of steel ($7850\text{kg}/\text{m}^3$)
Φ	configuration factor (conservatively taken as 1.0)

REFERENCES

1. Federal Emergency Management Agency, "World Trade Centre Building Performance Study: Data Collection, Preliminary Observations and Data Collections", Washington, DC., 2002.

2. Fitzpatrick, T., et al., "A Briefing on the World Trade Centre Attacks", Fire Protection Engineering, No. 13, 2002 (Winter).
3. British Standards Institution, BS.5950: Part8: Code of Practice for the Fire Protection of Structural Steelwork, UK, 1990.
4. British Standards Institution, BS.6399: Part1: Code of Practice for dead and imposed loads, UK, 1996.
5. Ranby, A., Inha, T., and Myllymäki, J., Structural Steel Fire Design, SBI Publication 134, Sweden, 2000.
6. European Committee for Standardisation, ENV 1991-1-2: Eurocode 1: Actions on Structures. Part1.2: General Actions: Actions on Structures Exposed to Fire. BE, 1991.
7. International Organization for Standardization, ISO834: Fire resistance tests - Elements of building construction, Geneva, 1975.
8. Milke, J., "Study of Building Performance in the WTC Disaster", Fire protection Engineering, No.18, 2003 (Spring).
9. European Committee for Standardisation, ENV 1994-1-2: Eurocode 4: Design of Composite Steel and Concrete Structures. Part 1.2: General Rules: Structural Fire Design, Brussels. BE, 1994.
10. Huang, Z., Platten, A., and Roberts, J. "Non-linear finite element model to predict temperature histories within reinforced concrete in fires." Building and Environment, Vol. 31, No. 2, 1996, pp.109-118.
11. Purkiss, J.A., Fire Safety Engineering Design of Structures, Butterworth & Heinemann, Oxford, UK, 1996.
12. European Committee for Standardisation, ENV 1993-1-2: Eurocode 3: Design of Steel Structures. Part1.2: General Rules: Structural Design for Fire, Brussels. BE, 1993.
13. Neville, A. M., Properties of Concrete 4th edition, Addition Wesley Longman Limited, 1998.
14. Rots, J.G., et al, "The need for fracture mechanics options in finite element models for concrete structures", Proc. Int. Conf. on Computer Aided Analysis and Design of Concrete Structures PartI, F. Damjanic et al., eds., Pineridge Press, 1984, pp. 19-32.
15. Huang, Z. and Plattern, "A., Nonlinear finite element analysis of planar reinforce concrete members subjected to fire", ACI Structural Journal, Vol. 94, No. 3, 1997, pp. 272-282.
16. Cai, J., Burgess, I.W., and Plank, R.J., "A generalised steel/reinforced beam-column element model for fire conditions", Engineering Structures, Vol. 25, No. 6, 2003, pp. 817-833.
17. American Society of Civil Engineering, Finite Element Analysis of Reinforced Concrete, New York, 1984
18. Barzegar-Jamshidi, F., Non-linear finite element analysis of reinforced concrete under short term monotonic loading, PhD thesis, University of Illinois at Urbana-Champaign, Ill.
19. Najjar, S.R., Three Dimensional analysis of steel frames and sub-frames in fire, PhD thesis, University of Sheffield, 1994.

20. Bailey, C.G., Simulation of the structural behaviour of steel-framed buildings in fire, PhD thesis, University of Sheffield, 1995.
21. Shepherd, P., The performance in fire of restrained columns in steel-framed construction, PhD Thesis, University of Sheffield, 1999.
22. Cai, J., Developments in modelling of composite building structures in fire, PhD thesis, University of Sheffield, 2002.
23. Huang, Z., Burgess, I.W. & Plank, R.J., "Modelling membrane action of concrete slabs in composite buildings in fire I: Theoretical development", ASCE Journal of Structural Engineering, Vol. 129, No. 8, 2003, pp.1093-1102.
24. Huang, Z., Burgess, I.W. & Plank, R.J., "Modelling membrane action of concrete slabs in composite buildings in fire II: Validations", ASCE Journal of Structural Engineering, Vol. 129, No. 8, 2003, pp.1103-1112.
25. Choi, S.K, Burgess, I.W. and Plank, R.J., "Structural behaviour of unrestrained composite truss systems in fire", 3rd European Conference on Steel Structures, Coimbra, Portugal, 2002, pp. 1459-1468.