



Development of a new in situ test method to measure the air permeability of high performance concretes

Yang, K., Basheer, PAM., Bai, Y., Magee, B., & Long, AE. (2014). Development of a new in situ test method to measure the air permeability of high performance concretes. *NDT and E International*, 64, 30-40.
<https://doi.org/10.1016/j.ndteint.2014.02.005>

[Link to publication record in Ulster University Research Portal](#)

Published in:
NDT and E International

Publication Status:
Published (in print/issue): 01/06/2014

DOI:
[10.1016/j.ndteint.2014.02.005](https://doi.org/10.1016/j.ndteint.2014.02.005)

Document Version
Author Accepted version

General rights
Copyright for the publications made accessible via Ulster University's Research Portal is retained by the author(s) and / or other copyright owners and it is a condition of accessing these publications that users recognise and abide by the legal requirements associated with these rights.

Take down policy
The Research Portal is Ulster University's institutional repository that provides access to Ulster's research outputs. Every effort has been made to ensure that content in the Research Portal does not infringe any person's rights, or applicable UK laws. If you discover content in the Research Portal that you believe breaches copyright or violates any law, please contact pure-support@ulster.ac.uk.

**Development of a new *in situ* test method
to measure the air permeability of high performance concretes**

K. Yang^a, P.A.M. Basheer^b, Bai Y^c, B.J. Magee^d and A.E. Long^b

^a College of Material Science and Engineering, Chongqing University, Chongqing, China

^b School of Planning, Architecture and Civil Engineering, Queen's University Belfast, Northern Ireland, UK

^c Civil, Environmental and Geomatic Engineering, University College London, England, UK

^d School of the Built Environment, Ulster University, Northern Ireland, UK

Abstract

Although several *in situ* techniques, including the Autoclam Permeability System, are available to examine normal concretes (NCs) for this purpose, none are sufficiently sensitive to quantify and distinguish relative high performance concrete (HPC) performance. Therefore, to assess the HPC performance characteristics using the Autoclam air permeability test methodology, two key modifications were investigated and a new test protocol developed. The first modification considered a reduced volume of compressed air applied to the test area (named LV test), and the second an increased test area (named A-75). The reliability of the proposed modifications was investigated by comparing against a laboratory-based gas permeability test method (RILEM air permeability test). Surface resistivity and relative humidity were assessed to evaluate the influence of moisture conditions on *in situ* air permeability test results. A strong correlation between LV test and RILEM air permeability test results was found when the free moisture near concrete surface regions (up to 20 mm) was removed. It was concluded that the LV test exhibits strong potential to become an established method for assessing *in situ* HPC permeability.

Key words

In situ air permeability test, high performance concrete, relative humidity, surface resistivity, RILEM gas permeability test, Autoclam air permeability test

1 Introduction

High performance concretes (HPCs) are typically designed with superior performance characteristics relative to normal concretes (NCs) [1-3]. Resulting enhanced durability of concrete structures containing HPCs is a key driving force behind their application [2,3]. This is particularly relevant given the large sums of money spent annually on repairing and maintaining structures worldwide [4,5]. Various grades of HPCs can be designed, manufactured and tested in laboratory conditions to satisfy design specifications for different service conditions [2,6,7]. However, it is not safe to assume at all times that pre-specified durability levels are achieved on site, as ultimate engineering concrete properties are not solely related to materials, mix proportions and service environments, but also factors which are difficult to control on site, such as manufacturing and delivery processes, as well as construction practices employed from initial placement to final curing [4,8,9]. As a result, a correlation between performance assumptions and *in situ* construction quality should ideally be considered.

To ensure the ultimate delivery of high performance in practice, on site evaluation is essential and so were many field techniques proposed [10-14]. Amongst these, assessment of concrete's near-surface permeation characteristics is recognised as a reliable tool to qualify durability [4,10,14,15], because deterioration of reinforced concrete usually involves ingress of aggressive substances from the surrounding environment [3,5,7,11]. Air permeability tests have gained popularity in recent years due to their short test duration and the fact that concrete pore structure is unaffected during testing [5,13,16]. Whilst a variety of field methods are available for the assessment of NC air permeability and some have become standards [4,10,11,17], no suitable *in situ* method exists for the assessment of HPCs. Previous research attempting to utilise currently available *in situ* methods has found that due to low test sensitivity, most are ineffective at quantifying permeation characteristics of concrete with

very low porosity and permeability [18-20]. This is unfortunate given that air permeability is an excellent parameter for *in situ* quality control [3,5,8]. Using the established Autoclam air permeability method, a preliminary study by Yang et al. [21] identified two potential approaches for improving test sensitivity sufficiently to assess relative HPC permeability. This included using a reduced volume of compressed air exposed to the test area (designated as low volume, or LV, Autoclam air permeability test) and using a larger test area (75mm internal diameter base ring instead of 50mm). Whilst positive results were obtained using these modifications, further assessment and quantification of basic instrument performance characteristics and measurement processes is required before widespread *in situ* use. In addition, reliability needs to be established by testing a wider range of HPCs as well as any preconditioning requirements for the proposed methods.

2 Aims and scope of the research

Against this background, the aim of the current study was to assess the performance characteristics of these modified test approaches that enable more sensitive and reliable determination of air permeability of HPCs. This requires:

1. Establishment of the preconditioning regime for air permeability measurement, targeting at selecting a suitable indicator to reflect concrete moisture conditions.
2. Assessment of the effect of moisture on air permeability tests with the aim of identifying an initial condition for *in situ* measurement.
3. Validation of the proposed technique by comparing against results obtained from a standard laboratory-based RILEM gas permeability test method.
4. Comparison of two modified air permeability tests in order to select the better test for future research investigations.

The research scope is to assess the HPC performance characteristics using the Autoclam air permeability test methodology, after incorporating two key modifications investigated and a new test protocol developed. The first modification considered a reduced volume of compressed air applied to the test area (named LV test), and the second an increased test area (named A-75). The reliability of the proposed modifications was investigated by comparing against a laboratory-based gas permeability test method (RILEM air permeability test). Surface resistivity and relative humidity (RH) were assessed to evaluate the influence of moisture conditions on *in situ* air permeability test results. The results obtained from this investigation led to the development of a new protocol for measuring the *in situ* air permeability of HPCs and a proposal for eliminating the effect of moisture content on measured air permeability values. Furthermore, the suitability of RH and resistivity measurements for quantifying the influence of moisture content of the HPCs on air permeability was established.

3 Experiment programme

3.1. Variables investigated

As shown in **Table 1**, the two key variables studied in this work included concrete mix type and test methodology using the Autoclam air permeability apparatus. In terms of mix type, one normal concrete (control) and five HPCs were investigated. The intention was to assess a sufficiently wide range of performance levels to allow accuracy to be established adequately [22]. In terms of test methodology, three approaches were considered; namely the conventional Autoclam air permeability test with both a 50 and 75mm base ring (designated as A-50 and A-75 respectively) and the low volume Autoclam air permeability test (designated as LV-test). To investigate the effect of moisture condition on results obtained, all three test methods were carried out on concretes exposed to five

different drying durations. Moisture conditions of test specimens were subsequently quantified using relative humidity and surface resistivity measurements.

3.2. Materials and concrete mixes

Based on previous studies carried out at Queen's University Belfast [18,23], mix compositions of the NC and five HPCs were decided (reported in **Tables 1 and 2**). Typical of HPCs [1-3,8], four of the HPC mixes contained SCMs, including microsilica (MS), pulverised fuel ash (PFA) and ground granulated blast-furnace slag (GGBS).

CEM-I cement conforming to BS-EN 197 [24] was used where applicable. PFA was obtained from Kilroot Power Station in Northern Ireland, UK, with its properties conforming to BS-EN 450 [25]. Microsilica used was in the form of slurry from Elkem, manufactured to BS-EN 13263-1 [26]. GGBS was from Civil Marine Slag Cement Ltd, manufactured according to BS-EN 15167 [27]. The superplasticiser was a polycarboxylic acid based polymer. The fine aggregate was medium graded natural sand and the coarse aggregate was crushed basalt with 10 and 20 mm size proportions in equal mass. The moisture condition of the aggregates was controlled by pre-drying in an oven at $105(\pm 5)^{\circ}\text{C}$ for 24 hours, followed by cooling to $20(\pm 1)^{\circ}\text{C}$ for one day before casting.

3.3. Preparation of specimens and testing

Concrete mixing was undertaken in accordance with BS 1881, Part 125: 2005 [28] and followed immediately by slump and air content testing in accordance with BS-EN 12350-2 [29] BS-EN 12350-7 [30] respectively. Three $230\times 230\times 100\text{mm}$ slabs and six 100mm cubes were manufactured for each mix. Moulds were filled with concrete in two equal layers, with each being compacted using a vibrating table until air bubbles stopped appearing on the surface. All test specimens were covered with wet hessian and placed in a constant temperature room at $18(\pm 2)^{\circ}\text{C}$. After 24 hours, specimens were removed from their moulds and cured in a water bath at constant temperature of $20(\pm 1)^{\circ}\text{C}$.

Cube specimens were removed after 28 and 56 days and tested for compressive strength according to BS-EN 12390-3 [31].

Fresh properties and compressive strength values for each concrete are shown in **Table 3**. Disparity between the normal concrete (NC) and HPC is evidenced by the variation in 28-day compressive strength, which was 37 N/mm² for mix NC and, on average, 70 N/mm² for the five HPC mixes.

Slab specimens were removed from the water bath after three days, wrapped in polythene sheets and relocated to a constant temperature room (20±1°C) for 90 days to remove any influence of hydration on subsequent test results. After this 90 day period, sides of the slab were painted with three coats of an epoxy paint to prevent moisture transport. Specimens were then saturated in water in layers by an incremental immersion method in order to ensure that the specimens were saturated whilst the entrapped air was removed [32].

At the end of the saturation period, slabs were placed in a drying cabinet (40±1°C and 35% RH). After drying for 7 days, they were removed from the oven and cooled in a constant temperature room (20 ± 2 °C) for 1 day prior to carrying out the three Autoclam air permeability tests, relative humidity and surface resistivity measurements. Once these tests were completed, specimens were dried in the oven again for another 7 days and measurements repeated after cooling to room temperature. This process was repeated when concrete slabs were dried for 21, 28 and 35 days.

After carrying out the last set of measurements, three cores (3×50 mm diameter) were cut from the specimens and dried in an oven at 40°C until they reached constant weight. After drying, the cores were left in a constant temperature room (20 ± 2°C, 50% RH) to cool for one day. The RILEM gas permeability test [33] was then carried out as described in section 2.4.

The curing, preparation, drying and testing regime for the slab specimens is summarised in **Table 4**.

3.4. *Test methods*

3.4.1 *Relative humidity test*

A chilled mirror dew-point probe, manufactured by Michell Ltd., was used for relative humidity (RH) measurements of the surface and at depths of 10 and 20 mm in holes drilled in the slab specimens, as shown in **Figure 1**. As per the recommendations of an investigation by Nolan et al. [32], the probe was left in place for one hour to obtain stable RH readings. Each value shown is the mean of two measurements (one measurement in each of the test blocks).

3.4.2 *Surface resistivity test*

With surface resistivity representing another technique to assess near-surface concrete moisture conditions [9], the non-destructive Wenner probe method (see **Figure 2**) was employed to measure electrical resistivity. This technique measures potential differences across two inner electrodes by applying alternating current at a constant magnitude between outer electrodes. Resistivity is given by the following equation:

$$\rho=2\pi a(V/I) \tag{1}$$

where: ρ is the surface resistivity (Ωm); a is the spacing between probes (m); V is the potential difference across the electrodes (V); and I is the applied current (A).

The spacing ‘a’ of the Wenner probe defines the electrical flow patterns and specifies the effective tested region. As such, resistivity gradients near the surface region can be quantitatively investigated by varying the spacing [9]. Therefore, this study utilised two spacings (20 and 30mm) to identify whether resistivity values can be used as an alternative approach to estimating near-surface moisture conditions.

After drying, five measurements were carried out on the surface of one randomly selected slab for each concrete mix and the average value reported.

3.4.3 Autoclam air permeability test

As described previously, three Autoclam-based air permeability tests were undertaken as part of this study. The first test employed a conventional 50mm diameter base ring (designated as A-50), which is the base ring size widely used for testing normal concrete. The second test employed a 75mm diameter base ring (designated as A-75), modified for testing high performance concrete. The third test was undertaken using a modified low volume of compressed air (designated LV test), with a 50 mm base ring. **Figure 3** shows the instruments used in this study and further details have been published elsewhere [21].

The three test methods have the same working principle and hence similar procedures were applied. A base ring was used to isolate the test area on the surface of the concrete blocks and the instrument was pressurised manually. When the pressure reached 0.5 bar, the test commenced automatically. With air escaping through the pores in the test specimen, pressure decreased and was monitored every minute for 15 minutes. To calculate the value of air permeability index (*API*), natural logarithms of air pressure were plotted against time. The slope of the last 10 data points was reported as an air permeability index, *API*, [in ln(bar)/min]. *API* values lower than 0.1 ln(bar)/min from the conventional Autoclam test with a 50mm base ring generally represent good quality concrete [10]. However, this cannot be applied directly to qualify the durability of HPCs because most values for HPCs would be less than 0.1 ln(bar)/min [20,21].

3.4.4 RILEM gas permeability test

Coefficients of gas permeability were determined according to RILEM TC-116 PCD [33] using three 50mm diameter cores for each mix. Each specimen was placed in the permeability cell and gas

(Nitrogen) applied under 1.2 bar pressure. The test pressure was kept at this value and flow rates measured. Gas permeability coefficients were calculated based on Darcy's equation, without accounting for any gas slippage effects on the rate of flow, as follows:

$$K_g = 2\mu L P_o Q_s / A (P_i^2 - P_o^2) \quad (2)$$

Where: K_g is the gas permeability coefficient (m^2); μ is dynamic viscosity of N_2 (Ns/m^2) at $20\text{ }^\circ\text{C}$; L is the sample thickness (m); A is the section area subjected to flow (m^2); Q_s is volume flow rate of gas (m^3/s); and P_i/P_o is the inlet/outlet pressure (N/m^2).

4 Results and discussion

4.1. Moisture condition after drying

Illustrated in **Figure 4** is the influence of drying duration on surface resistivity for the two Wenner probe spacings considered (20 and 30mm). With loss of moisture connectivity within capillary pores leading to increased concrete resistivity [9, 34], perhaps not surprisingly it was found that surface resistivity generally increased with prolonged drying periods. No significant difference in surface resistivity was noted when Wenner probe spacing increased from 20 to 30 mm, and readings for all concretes tended to stabilise after 28 days of drying. Resistivity values for the different concretes varied considerably, but reflecting their inherent material and performance differences. It was noted that conclusions drawn for a given concrete were difficult to extend to other concretes and no general experimental strategy could be established. Therefore, it was concluded that surface resistivity not only reflects changes of moisture condition, but also the porosity and permeation properties of the concrete. As such, it is very difficult to propose a reference value of surface resistivity to be used as an indication of the dryness of different concretes. In agreement with conclusions drawn by Romer

[19], therefore, air permeability compensations for the effects of moisture in HPCs cannot be based on surface resistivity measurements.

In terms of using RH as a reliable indication of concrete moisture condition, **Figure 5** reports measured values at different concrete depths (surface, 10 and 20mm) after different drying periods (7, 14, 21, 28 and 35 days). As shown, surface RH values varied between 40 and 55% across the whole drying period and no general pattern was identifiable. It is generally recognised that when RH values are below 60%, little free moisture is present in the capillary pore system [35,36]. From **Figure 5**, therefore, it can be assumed that low levels of free surface moisture are present after 7 days of drying. Whilst no specific trends between RH and drying duration were noted for all of the concrete mixes, this conclusion is consistent with previous related research [32].

For RH testing undertaken at depths of 10 and 20mm, clearly apparent from **Figure 5** are progressive reductions of RH with drying duration. Perhaps not surprisingly, RH values at 10mm were lower across the board than at 20mm and decreased with drying time at a more rapid rate.

At both 10 and 20mm depths, equilibrium was not established even after 35 days of drying. This suggests that, consistent with previous studies [32,35,37], drying alone is not sufficient to obtain uniform moisture distribution across specimens. It is clear, however, that RH values at both 10 and 20mm depths were lower than 60% after drying for 21 days, indicating very low levels of free moisture in this region (i.e. from the surface to 20mm) [35-37]. This observation suggests that RH measurement at depth is a suitable indicator to assess the moisture condition in concrete.

4.2. *In situ air permeability after drying*

The influence of drying duration on results obtained from the three Autoclam air permeability tests is shown in **Figures 6(a)-(c)**.

For the control mix NC, accuracy of the test methods was anticipated based on previous research [32] confirming the conventional Autoclam test's effectiveness to assess NC permeability when RH levels at a 10mm depth are below 80%. From **Figure 5**, it has already been shown that RH values for all concretes in this study were below 70% after only 7 days of drying. From **Figure 6**, a clear influence of drying was noted for the control NC mix, with API values generally increasing with drying duration for all three test methods. This increase was most pronounced for the LV test, as was the clear distinction between the NC result and those obtained for the various HPC mixes.

From **Figure 6(a)**, it can be seen that the API values obtained for all HPC mixes using test A-50 were low and within a narrow range (between 0.03 and 0.05). No obvious variation or result trend was noted during the entire drying period. Within such a small range, it was not surprising to see the five HPC data sets coinciding with each other. This suggests that due to its low sensitivity, the A-50 test is not capable of distinguishing between relative performance and changes caused by moisture variations for HPC. This is perhaps not surprising given that the A-50 test method was developed in the 1990s for measuring the permeability of NCs [10].

In terms of API results obtained from the A-75 test, **Figure 6(b)** shows generally increasing values with drying duration up to 21 days, with data stabilising thereafter. Also apparent was improved test sensitivity, with more pronounced differences (ranging from 0.03 to 0.10) noted between the different HPCs.

As shown in **Figure 6(c)**, the LV test produced the highest API values for all mixes and drying durations. Relative to the A-75 test, performance differences between the HPC mixes were even more pronounced, with values ranging from 0.05 to 0.18. This trend implies that the LV test has the highest sensitivity among the three test methods investigated when assessing HPC performance.

Despite having RH values less than 80% at 10mm after 7 days of drying (see **Figure 5**), also noted from **Figure 6** for the HPC mixes was a level of result randomness at early drying ages. This was

particularly apparent for the LV-test where a more pronounced spread of relative values was recorded. This trend suggests that, in contrast to NC, the influence of moisture for HPCs needs to be further removed or controlled in order to obtain reliable results. From the trends noted from **Figures 5 and 6**, it is clear that for accurate evaluations of moisture effect on API for HPCs, measurement of RH at depths greater than 10mm is merited.

Results shown in **Figures 6(b) and (c)** for the A-75 and LV tests highlighted that for HPCs, ranking of API values was almost constant after 21 days of drying.

Against this background, the results from the current study suggest that 21 days of oven drying (40°C) is an appropriate preconditioning laboratory regime to remove moisture effects prior to HPC air permeability testing. Obviously, this level of drying is a challenge for the use of *in situ* air permeability tests to assess the performance of HPCs in structures.

4.3. Influence of drying on reliability of Autoclam air permeability tests

The next phase of the research focused on assessing the reliability of the proposed Autoclam test methods. This was achieved by comparing Autoclam results with reference permeability coefficients obtained from RILEM steady state gas permeability test. As shown in **Table 5**, average gas coefficients obtained from the RILEM gas permeability testing for all concretes were relatively low, ranging from 2.5 to $12 \times 10^{-17} \text{m}^2$. As expected, the control NC mix achieved the highest average value of $12 \times 10^{-17} \text{m}^2$. In comparison, the HPC mixes achieved values which were on average around three times lower. The lowest ($2.5 \times 10^{-17} \text{m}^2$) and highest ($6.2 \times 10^{-17} \text{m}^2$) average HPC permeability values were achieved by the PFA and GF mixes respectively.

Using the results obtained from both the Autoclam and RILEM test methods, a linear regression analysis was subsequently performed to assess the relative performance. As data from the different tests could not easily be compared directly due to their non-homogeneous variance and the different

units used for expressing the results, results were transformed by log-function and normalised as follows [38,39]:

$$Z = (x_i - x_{av}) / SD \quad (3)$$

where: Z is the normalised data; x_i the log transformed data; x_{av} the average value of the specific method; and SD the standard deviation of the specific method. With no physical meaning, the values obtained in this way were used to reflect relative differences in concrete permeability properties only.

The relationship between normalised values of K_g (RILEM gas permeability test) and normalised results from the Autoclam-based A-50, A-75 and LV tests are given in **Figures 7, 8 and 9** respectively. In each figure, plots are included for results obtained after 7, 14, 21, 28 and 35 days of drying to enable an investigation of its influence on test reliability. A summary of the regression analysis data supporting **Figures 7-9** is additionally provided in **Table 6**.

For all three Autoclam test methods, **Figures 7-9** indicate general positive relationships between normalised API and RILEM gas permeability values. This is verified by the fact that the p-values obtained from regression analysis were all lower than 0.05, meaning that the relationship between the independent variable (K_g) and the dependent variable (API) can be considered to be statistically significant. Also apparent is the significant influence of drying time, with correlations between API and K_g strengthening for all three Autoclam tests as the drying duration increased from 7 to 35 days. For the LV test, for example, R^2 values for the relationship increased progressively from 0.443 at 7 days to 0.881 at 35 days. This trend further strengthens the importance of precondition drying before undertaking air permeability measurements.

Across the range of drying conditions considered, the strongest correlations between API and K_g were noted for the A-50 and LV tests. For both, respective increases and decreases of R^2 and error of

regression were noted with prolonged drying durations, with values generally stabilising after 14 days of drying. As moisture conditions in HPC mixes are known to be generally stable due to their dense pore structure [36,40], prolonged drying is needed to remove this moisture. This trend has already been confirmed in **Figure 5** and further justifies the improved relationships between API and K_g with prolonged drying period as plotted in **Figures 7-9**.

When comparing the similar reliability of the A-50 and LV tests using the results in **Table 6**, however, it is important to bear in mind the very poor levels of sensitivity noted for the former in **Figure 6**. This phenomenon indicates that test sensitivity and reliability are two different characteristics that cannot be viewed independently. From this study, therefore, the LV test appears to be the most appropriate method for assessing HPC air permeability.

To confirm the conclusion of the linear regression analysis, three basic hypotheses were subsequently verified [38,39]. Final checks were undertaken to ensure that errors were independent of the fitted values, normally distributed and had equal variances. Graphical analysis of the residual plots was used to check these hypothesis [39]. The normal distribution of errors was confirmed by a probability plot, while the other two were checked using a plot of the residuals against the fitted values [38]. For the LV test, results of this analysis are shown in **Figure 10**, which contains five separate plots relating to the drying periods of 7, 14, 21, 28 and 35 days. All of the probability plots approximate a straight line, meaning that errors are normally distributed. Plots of residuals versus fitted values show that the former are randomly scattered around zero, indicating no non-consistent variability over the data range. Furthermore, there is no evidence to show dependence between residuals and fitted values. As such, the three hypotheses are proven and the interpretation of the regression analysis justified.

Against the background of this experimental work and analysis, the Autoclam-based LV test exhibits the best performance and is recommended as a new test method for assessing HPCs, using test

specimens preconditioned in an oven at 40°C for 21 days. For site applications, this means that the concrete should achieve this state of internal moisture content up to a depth of at least 20mm before the *in situ* air permeability test can be used to assess the performance of HPC in structures.

5 Conclusions

This study was undertaken to propose a scientifically sound method capable of distinguishing the air permeability of different HPCs, by taking into account of their moisture content and the influence of drying. The following main conclusions have been drawn based on the results reported in this paper:

- 1) Results of RH testing for HPC mixes do not show significant variation after 21 days of specimen drying in an oven at 40°C. RH readings within the near-surface region (surface to 20mm depth) of below 60% are achievable, meaning no influence of moisture in capillaries on measured air permeability results. That is, RH testing is a reliable indicator to eliminate the influence of moisture on air permeability testing and the RH values in the near-surface region (from surface to 20mm depth) of HPC should be less than 60% to get reliable air permeability values.
- 2) Values of HPC surface resistivity do not show significant variations after 21 days of drying. This method is not an appropriate approach to reflect the moisture conditions; therefore, no critical value can be proposed for a range of concrete mix types.
- 3) The effect of moisture dominates air permeability measurements and may result in misleading conclusions for HPCs. To overcome this, specimen preconditioning in an oven at 40°C for more than 21 days (or similar extent of drying) is recommended. Results indicated that after drying for 21 days in this way, strong correlations between Autoclam air permeability test and RILEM gas permeability tests existed.

- 4) Combining findings of the sensitivity and reliability analysis, the Autoclam-based LV test performed best among the three Autoclam air permeability tests considered. This test is recommended, therefore, as a robust technique for determining the air permeability of HPCs.
- 5) The LV test method could be used to measure *in situ* air permeability of HPCs, but it should be noted that in order to yield reliable results, the concrete should be in a moisture state equivalent of 21 days of drying in an oven at 40°C, which can be assessed by measuring relative humidity, i.e. internal relative humidity of less than 60% in the near-surface region.

Acknowledgement

The authors gratefully acknowledge the financial support provided by both the Engineering and Physical Sciences Research Council and Queen's University Belfast for carrying out the investigation reported in this paper. The work was carried out at Queen's University Belfast (while K Yang, Y Bai and B Magee were working for Queen's University Belfast). Facilities provided by the School of Planning, Architecture and Civil Engineering at Queen's are gratefully acknowledged.

References

- [1] Neville AM, Aitcin PC. High performance concrete- An overview. *Materials and Structures*. 1998;31:111-117.
- [2] Malier Y. *High Performance Concrete: From Material to Structure*: Spon; 1992.
- [3] Mehta PK, Monteiro PJM. *Concrete: Microstructure, Properties, and Materials*. 3rd ed: McGraw Hill; 2006.
- [4] Long AE, Henderson GD, Montgomery FR. Why assess the properties of near-surface concrete. *Construction and Building Materials*. 2001;15:65-79.
- [5] du Preez, AA, Alexader, MG. A site study of durability index for concrete in marine conditions. *Materials and Structures*, 2004;37:146-154.
- [6] Iqbal, KM. Mix proportions for HPC incorporating multi-cementitious composites using artificial neural networks. *Construction and Building Materials*, 2012;28:14-20.
- [7] Hamami, AA, Turcry, P, Al-Moktar, A. Influence of mix proportions on microstructure and gas permeability of cement pastes and mortars. *Cement and Concrete Research*, 2012;42:490-498.
- [8] Neville AM. *Properties of concrete*. 4th ed: John Wiley&Sons; 1996.
- [9] Millard SG, Harrison JA, Gowers KR. Practical measurement of concrete resistivity. *British Journal of Non-destructive Testing*. 1991;33:50-63.
- [10] Basheer PAM, Montgomery FR, Long AE. 'CLAM' tests for measuring in situ permeation properties of concrete. *Nondestructive Testing and Evaluation*. 1995;12:53-73.
- [11] Figg JW. Methods of measuring the air and water permeability of concrete. *Magazine of Concrete Research*. 1973;25:213-219.
- [12] Shaw, MR, Millard, SG, Molyneaux, TCK, Taylor, MJ, Bungey, JH. Location of steel reinforcement in concrete using ground penetrating radar and neural networks. *NDT&E International*, 2005;38:203-212.
- [13] Kucharczykova, B, Mlsak, P, Vymazal, T. Determination and evaluation of the air permeability coefficient using Torrent permeability tester. *Russian Journal of Non-destructive Testing*. 2010;46:226-233.
- [14] Torrent RT. A two-chamber vacuum cell for measuring the coefficient of permeability to air of the concrete cover on site. *Materials and Structures*. 1992;25:358-365.

- [15] Basheer, PAM, Andrews, RJ, Robinson, DJ, Long, AE. 'PERMIT' ion migration test for measuring the chloride ion transport of concrete on site. *NDT&E International*, 2005;38;219-229.
- [16] Githachuri, K, Alexander, MG, Moyo, P. Durability performance of a range of marine concretes and the applicability of the South African service life prediction model. *Materials and Structures*, 2012;45;185-198.
- [17] Denarie, E, Jacobs, F, Leemann, A, Teruzzi, T, Torrent, RT. Specification and site control of the permeability of the cover concrete: The Swiss approach. In: Leung, C and Wan, KT (Eds.) *International RILEM Conference on Advances in Construction Materials Through Science and Engineering*, RILEM, 2011;478-485.
- [18] Elahi A, Basheer PAM, Nanukuttan SV, Khan QUZ. Mechanical and durability properties of high performance concretes containing supplementary cementitious materials. *Construction and Building Materials*. 2010;24:292-299.
- [19] Romer M. Effect of moisture and concrete composition on the Torrent permeability measurement. *Materials and Structures*. 2005;38:541-547.
- [20] Yang, K, Basheer, P.A.M., Magee, B and Bai, Y., Investigation of moisture condition and Autoclam sensitivity on air permeability measurements for both normal concrete and high performance concrete, *Construction and Building Materials*, 2013;48;306-314.
- [21] Yang K, Basheer PAM, Bai Y. Autoclam – An effective field method to measure permeability of high performance concretes. *2nd International Conference on Durability of Concrete Structures (ICDCS-2010)*. Hokkaido University, Sapporo, Japan,2010. 8 pages.
- [22] ISO-5725. Accuracy (trueness and precision) of measurement methods and results. Part 4: Basic methods for the determination of the trueness of a standard measurement method. ISO; 1994. 32 pages.
- [23] Russell, D., Basheer, P.A.M., Rankin, G.I.B. and Long, A.E. Effect of relative humidity and air permeability on prediction of the rate of carbonation of concrete, *Structures & Buildings*, The Institution of Civil Engineers, 2001;146;3;319-326.
- [24] BS-EN:197-1. Cement. Composition, specifications and conformity criteria for common cements. BSI; 2000. 52 pages.
- [25] BS-EN:450. Fly ash for concrete-Part 1: Definition, specifications and conformity criteria. BSI; 2005. 36 pages.

- [26] BS-EN:13263-1. Silica fume for concrete. Definitions, requirements and conformity criteria. BSI; 2009. 28 pages.
- [27] BS-EN:15167. Ground granulated blast furnace slag for use in concrete, mortar and grout-Part-1: Definitions, specifications and conformity criteria. BSI; 2006. 28 pages.
- [28] BS1881-125, Methods for mixing and sampling fresh concrete in the laboratory, BSI, 1986, 10 pages.
- [29] BS-EN:12350-2. Testing fresh concrete-2: Slump test. BSI; 2000. 8 pages.
- [30] BS-EN:12350-7. Testing fresh concrete-7: Air content. Pressure methods. BSI; 2000. 20 pages.
- [31] BS-EN:12390-3. Testing hardened concrete-3: Compressive strength of test specimens. BSI; 2009. 22 pages.
- [32] Basheer, PAM, Nolan, EA, McCarter, WJ and Long, AE. Effectiveness of in-situ moisture preconditioning methods for concrete, *Journal of Materials in Civil Engineering*, ASCE, 2000;12;131-138.
- [33] RILEM:TC116-PCD. Tests for gas permeability of concrete. B: Measurement of the gas permeability of concrete by the RILEM-CEMBUREAU method. *Materials and Structures*. 1999;32:176-178.
- [34] McCarter W, Ezirim H, Emerson M. Properties of concrete in the cover zone water penetration, sorptivity and ionic ingress. *Magazine of Concrete Research*. 1996;48:149-156.
- [35] Parrott LJ. Moisture conditioning and transport properties of concrete test specimens. *Materials and Structures*. 1994;27:460-468.
- [36] Baroghel-bouny V. Water vapour sorption experiments on hardened cementitious materials, Part I: Essential tool for analysis of hygral behaviour and its relation to pore structure. *Cement and Concrete Research*. 2007;37:414-437.
- [37] Burlion N. Induced anisotropic permeability due to drying of concrete. *Cement and Concrete Research*. 2003;33:679-687.
- [38] Graybill FA, Iyer HK. *Regression analysis: concepts and applications*: Duxbury Press; 1994.
- [39] Montgomery DC. *Design and Analysis of Experiments*. 4 ed: John Wiley & Sons; 1996.
- [40] Nilsson LO. Long-term moisture transport in high performance concrete. *Materials and Structures*. 2002;35:641-649.

Tables and Figures

List of Tables

Table 1 Experimental variables

Table 2 Concrete mix proportions (kg/m^3)

Table 3 Fresh properties and compressive strength of concrete

Table 4 Slab specimen curing, preparation, drying and testing regime

Table 5 Summary of the results of permeability coefficients of K_g

Table 6 Summary of the regression results between three Autoclam air permeability test methods and the RILEM gas permeability test method

List of Figures

Figure 1 Method of measuring RH at surface and in the preformed cavities

Figure 2 Surface resistivity meter

Figure 3 The three *in situ* air permeability tests used in this study

Figure 4 The influence of drying duration (d) on surface resistivity

Figure 5 Relative humidity values at different depths after drying for different periods

Figure 6 The overall comparison between three air permeability tests

Figure 7 Effect of drying on the relationship between A-50 and RIELM gas permeability test

Figure 8 Effect of drying on the relationship between A-75 and RIELM gas permeability test

Figure 9 Effect of drying on the relationship between LV and RIELM gas permeability test

Figure 10 The diagnostic plots for regression analysis of LV

Table 1 Experimental variables

Mix proportions*		Test variables***	
Control	One normal concrete: NC**	A-50	Oven drying at 40°C for 7, 14, 21,28, 35 days
		A-75	
		LV	
HPC	Five HPCs: MF, PC, PFA, GGBS, GF	A-50	Oven drying at 40°C for 7, 14, 21,28, 35 days
		A-75	
		LV	

* Proportion details of six concrete mixes are given in Table 2

*** NC - normal concrete

MF - HPC with both MS and PFA

PC - HPC with only PC

PFA - HPC with PFA

GGBS - HPC with GGBS

GF - HPC with both GGBS and PFA

** A-50 refers to conventional Autoclam testing with a 50mm base ring, A-75 refers to Autoclam testing with a modified 75mm base ring; LV refers to low volume Autoclam testing with a 50 mm base ring.

Table 2 Concrete mix proportions

Designation	Binder proportions (% by mass)	Material quantities (kg/m ³)							W/B ratio	SP (% by mass)
		PC	MS	GGBS	PFA	Water	FA	CA		
<i>Control normal concrete:</i>										
NC	100:0 Only PC	375	0	0	0	256	625	1136	0.68	0
<i>High performance concretes:</i>										
MF	73:7:20 PC:MS:PFA	352	36	0	97	145	652	1150	0.3	1.5
PC	100:0 Only PC	485	0	0	0	145	689	1150		1.3
PFA	80:20 PC:PFA	388	0	0	97	145	668	1150		1.4
GGBS	50:50 PC:GGBS	243	0	243	0	145	676	1150		1.4
GF	30:50:20 PC:GGBS:PFA	145	0	243	97	145	655	1150		1.3

Notes:

- 1) FA and CA represent fine and coarse aggregate contents respectively;
- 2) SP refers to superplasticiser dosage as a percentage by mass of the total binder content.

Table 3 Fresh properties and compressive strength of concrete

Mix	Slump (mm)	Air content (% by volume)	Compressive strength (N/mm ²)	
			28 day	56 day
MF	240	1.6	84.2	94.6
PC	225	1.0	81.8	87.3
PFA	220	0.6	81.3	90.7
GGBS	235	1.5	74.7	79.9
GF	195	1.7	62.8	69.7
NC	145	1.2	36.8	43.2

Table 4. Slab specimen curing, preparation, drying and testing regime

CURING REGIME / SPECIMEN PREPARATION				Comments
Test specimen curing and Preparation	Specimens de-moulded after 24 hours.			
	3 days	20±1°C	Constant temperature water bath.	Initial curing period.
	90 days	20±1°C	Wrapped in polythene sheet and located in a constant temperature room.	Intended to achieve the maximum degree of hydration and, thereby, remove the effect of hydration on subsequent test results.
	3 days	Sides painted with epoxy paint and specimens saturated by incremental immersion.		Sample preparation to prevent future moisture transport through sides.
Drying	1,2, 3, 4 or 5 weeks	50±1°C R.H. 35%	Drying cabinet.	Assessment of drying time on performance.
	1 day	~20°C	Wrapped in polythene and cooled to room temperature.	Pre-testing conditioning.
Testing: Relative humidity, surface resistivity and air permeability				Main testing programme.
Test specimen Preparation	3 days	50mm diameter cores extracted. Specimens dried in an oven at 40°C and 35% R.H. until the constant weight reached.		Specimen preparation before testing.
Confirm testing: RILEM gas permeability test				Confirmation testing.

Table 5. Permeability coefficients (K_g)

Concrete mix	K_g ($10^{-17}m^2$) results				Relative ranking
	Test 1	Test 2	Test 3	Average	
PFA	2.2	2.5	2.9	2.5	1
MF	2.8	2.4	4.0	3.1	2
PC	4.1	5.5	6.5	5.4	3
GGBS	5.5	6.0	-	5.8	4
GF	5.2	7.7	5.8	6.2	5
NC	12.0	12.0	-	12.0	6

Table 6 Summary of the regression results between Autoclam and RILEM permeability test methods

Correlation	Parameters of regression analysis	Drying duration (d)				
		7	14	21	28	35
A-50 Vs RILEM gas test	R ²	0.275	0.626	0.736	0.74	0.804
	Regression error	0.881	0.633	0.531	0.527	0.458
	F -Value	5.32	23.41	39.11	39.94	57.34
	P-value for F-test	0.037	<0.001	<0.001	<0.001	<0.001
A-75 Vs RILEM gas test	R ²	0.197	0.475	0.539	0.568	0.49
	Regression error	0.927	0.75	0.702	0.68	0.739
	F-value	3.44	12.66	16.4	18.42	13.46
	P-value for F-test	0.085	0.003	0.001	0.001	0.003
LV test Vs RILEM gas test	R ²	0.443	0.717	0.75	0.753	0.881
	Regression error	0.773	0.55	0.517	0.514	0.357
	F-value	11.12	35.50	42.07	42.66	103.86
	P-value for F-test	0.005	<0.001	<0.001	<0.001	<0.001

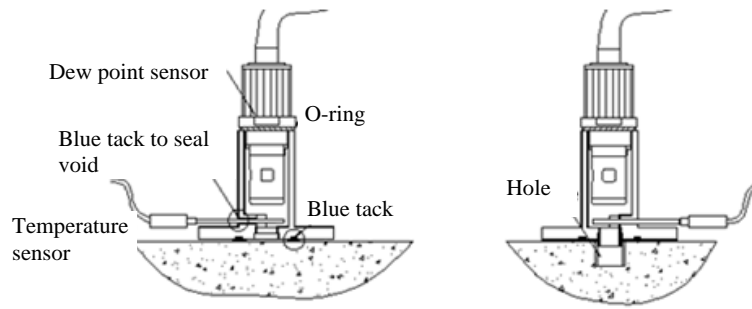

(a) Surface measurement (b) Measurement at different depths

Figure 1. Method of measuring RH at surface and in the preformed cavities

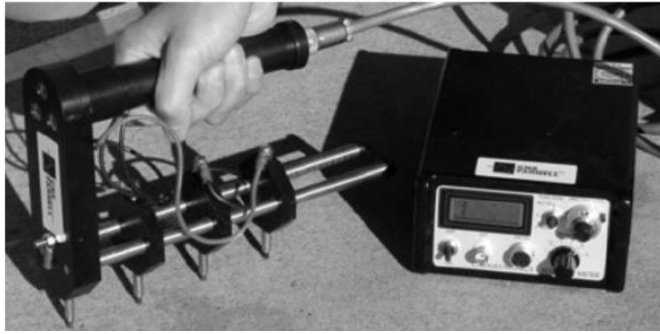
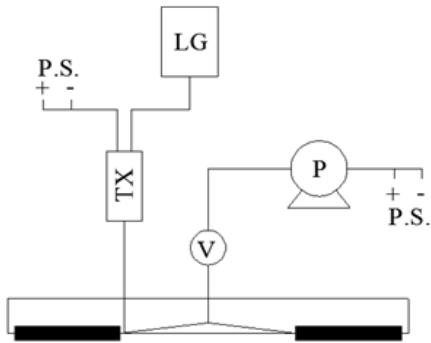

Figure 2 Surface resistivity meter



(a) Autoclam permeability system, including 50 and 75mm internal diameter test rings and syringe for applying air pressure



(b)

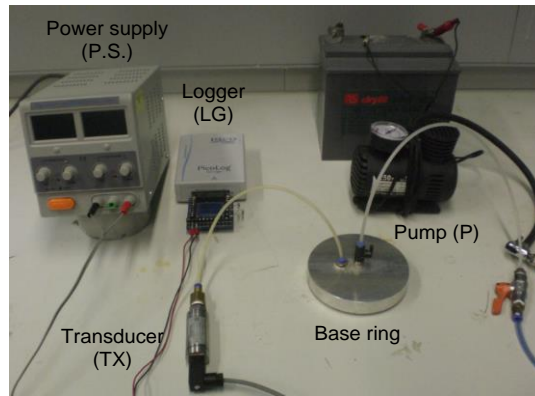

(c)

(b) Test schematic; (c) Low volume (LV) test instrument

Figure 3 Autoclam air permeability test apparatus

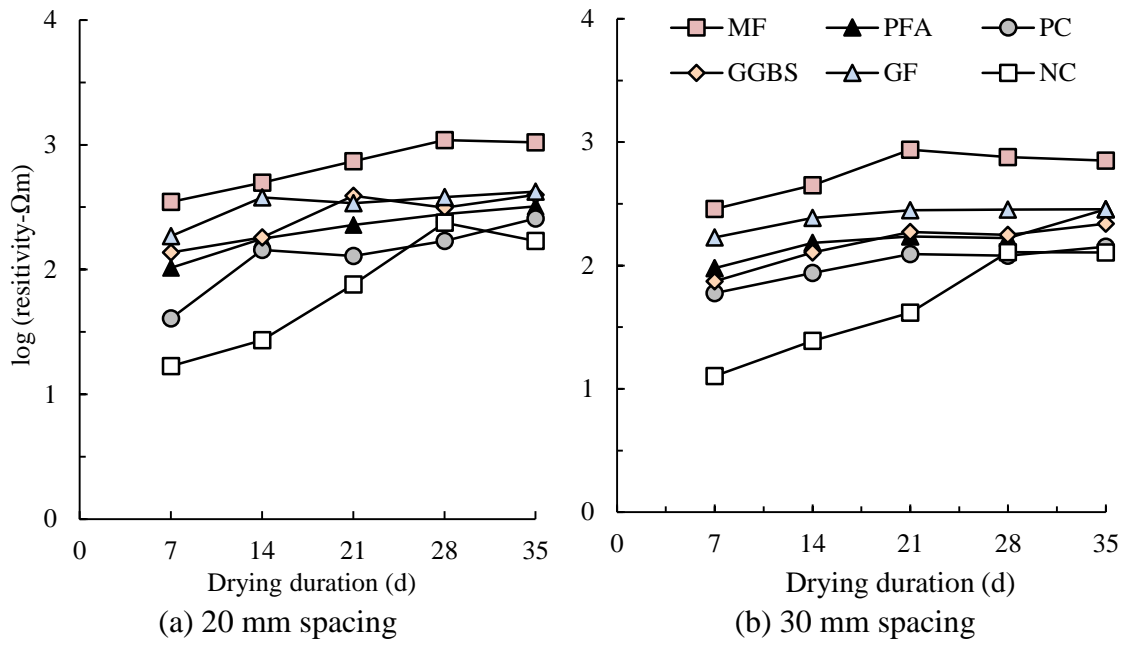

Figure 4 Influence of drying duration on surface resistivity

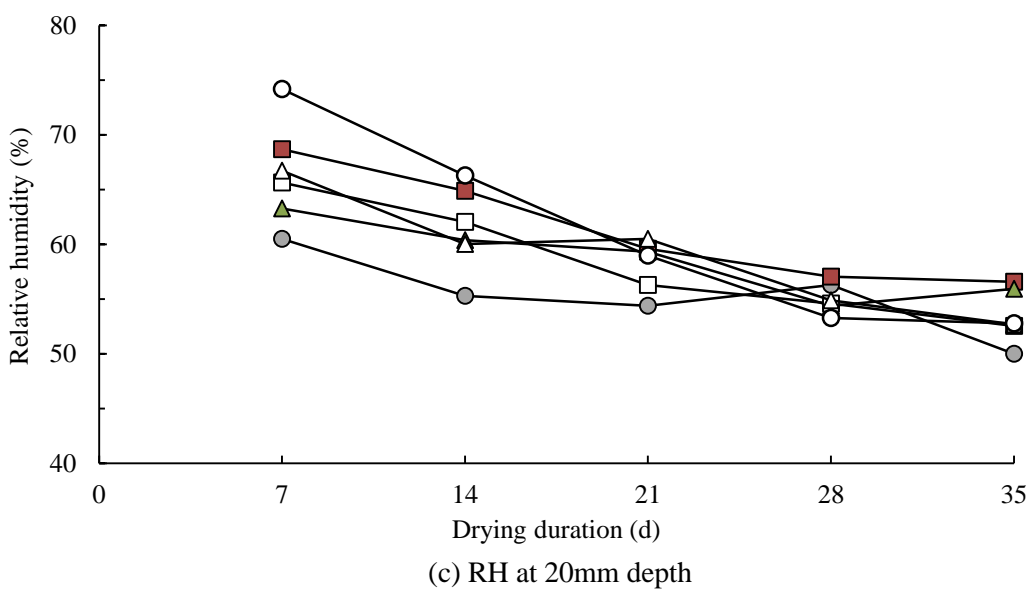
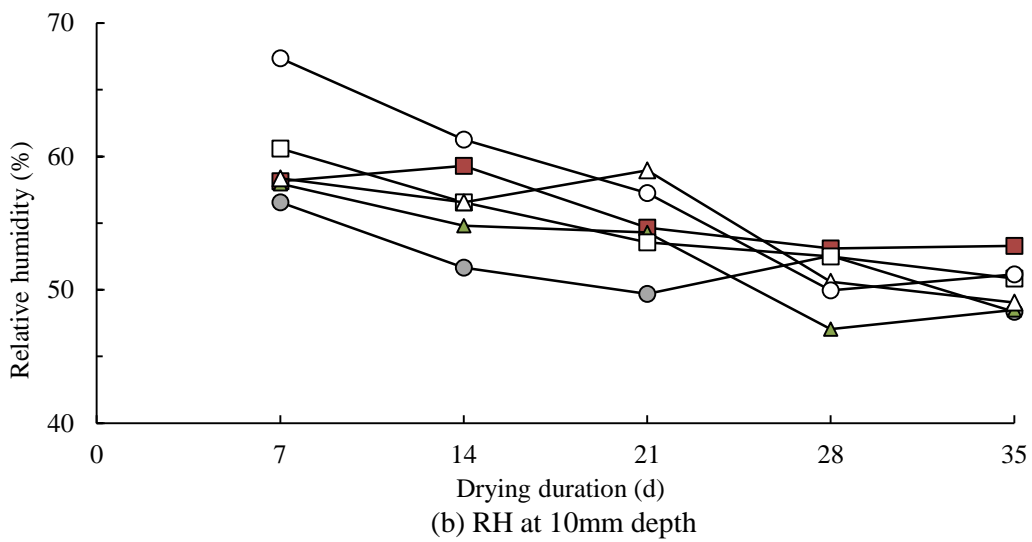
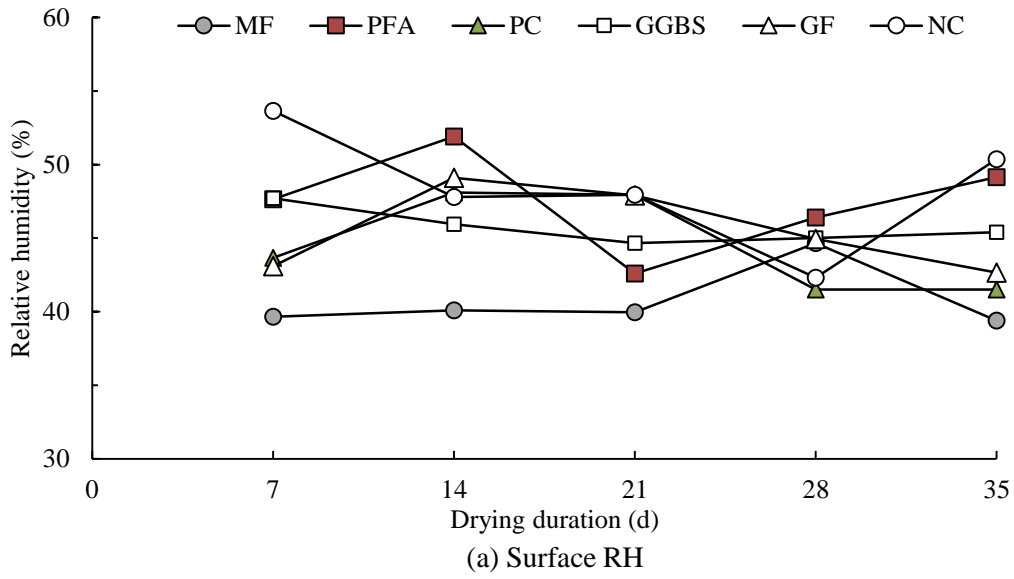
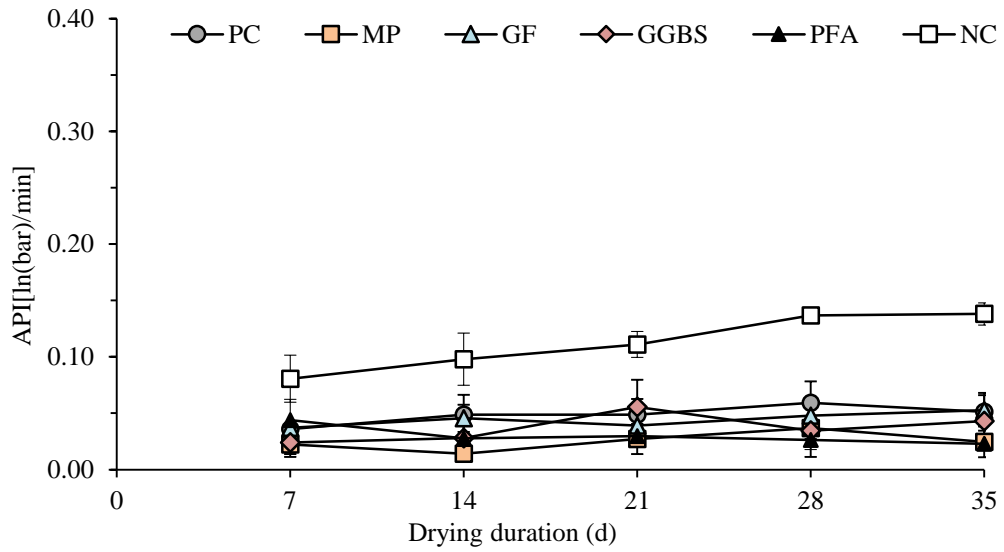
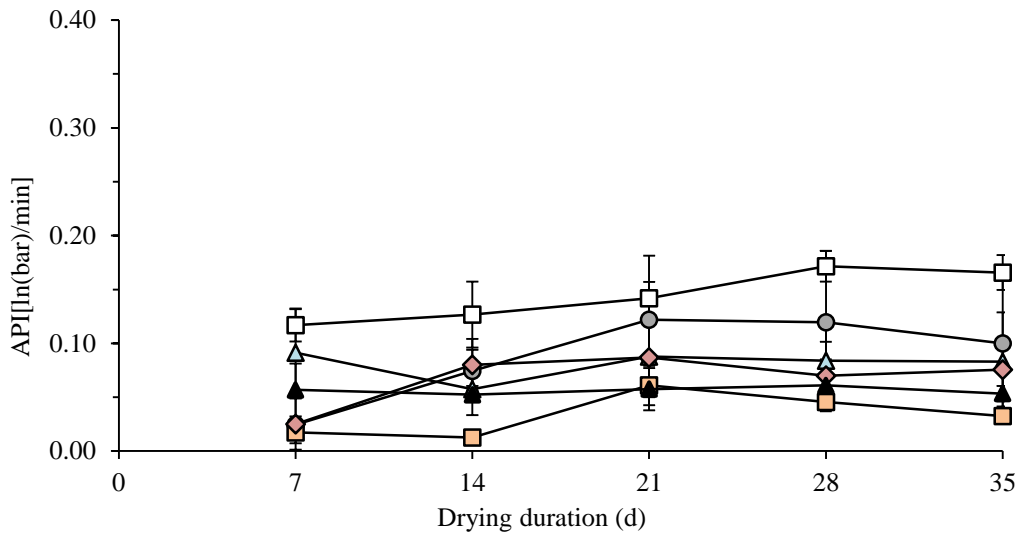

Figure 5 Relative humidity values at different depths after drying for different periods



(a) Conventional Autoclave air test with a 50mm diameter base ring (A-50)



(b) Conventional Autoclave air test with a 75mm diameter base ring (A-75)

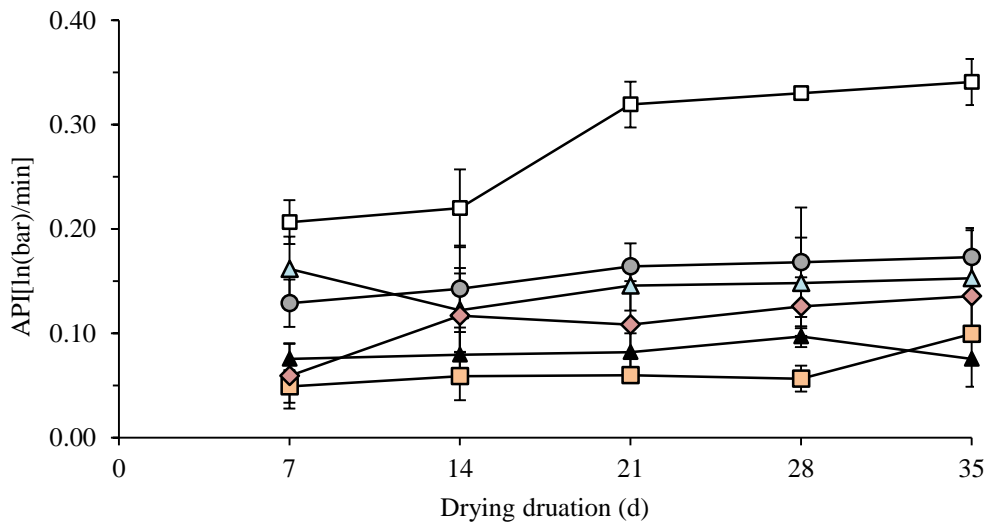

(c) Low volume test (LV)

Figure 6 Relationship between API value and drying duration for Autoclave-based tests methods

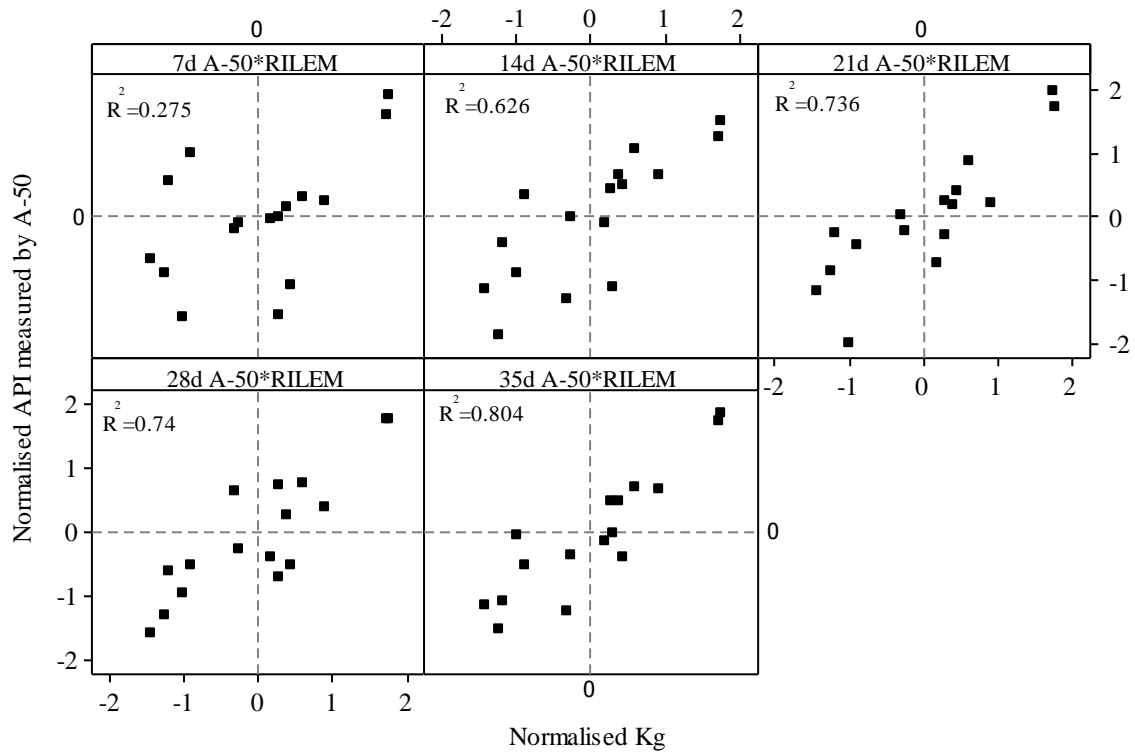

Figure 7 Effect of drying on relationship between A-50 and RIELM permeability tests

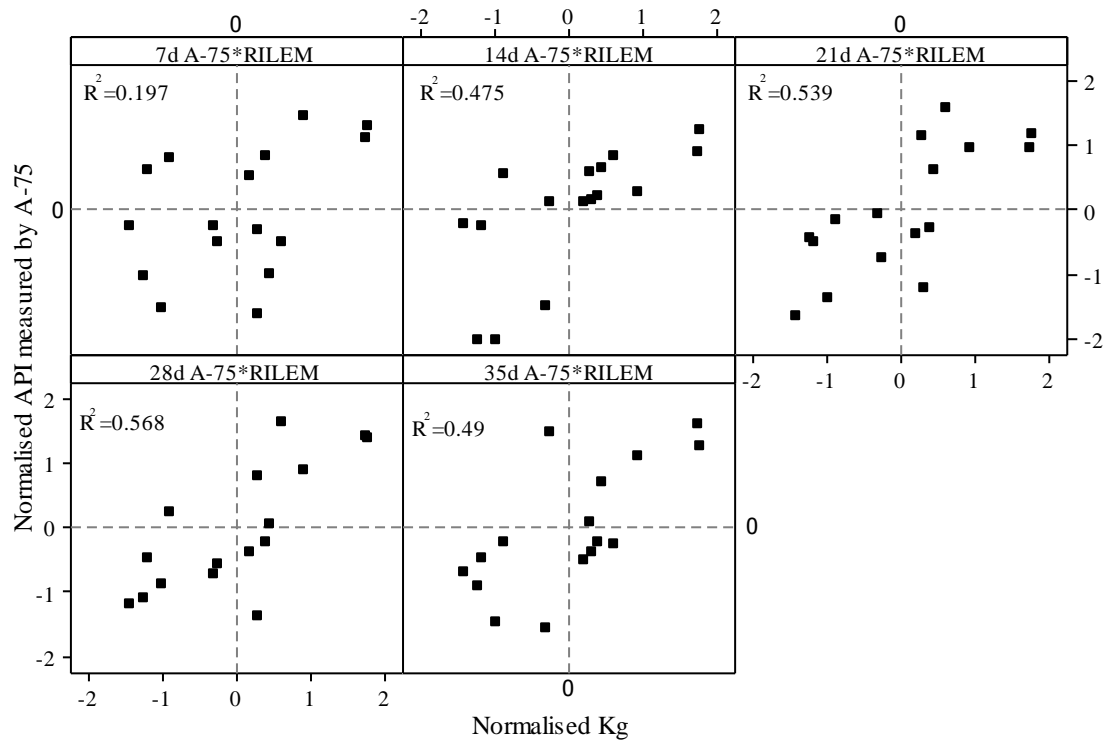

Figure 8 Effect of drying on relationship between A-75 and RILEM permeability tests

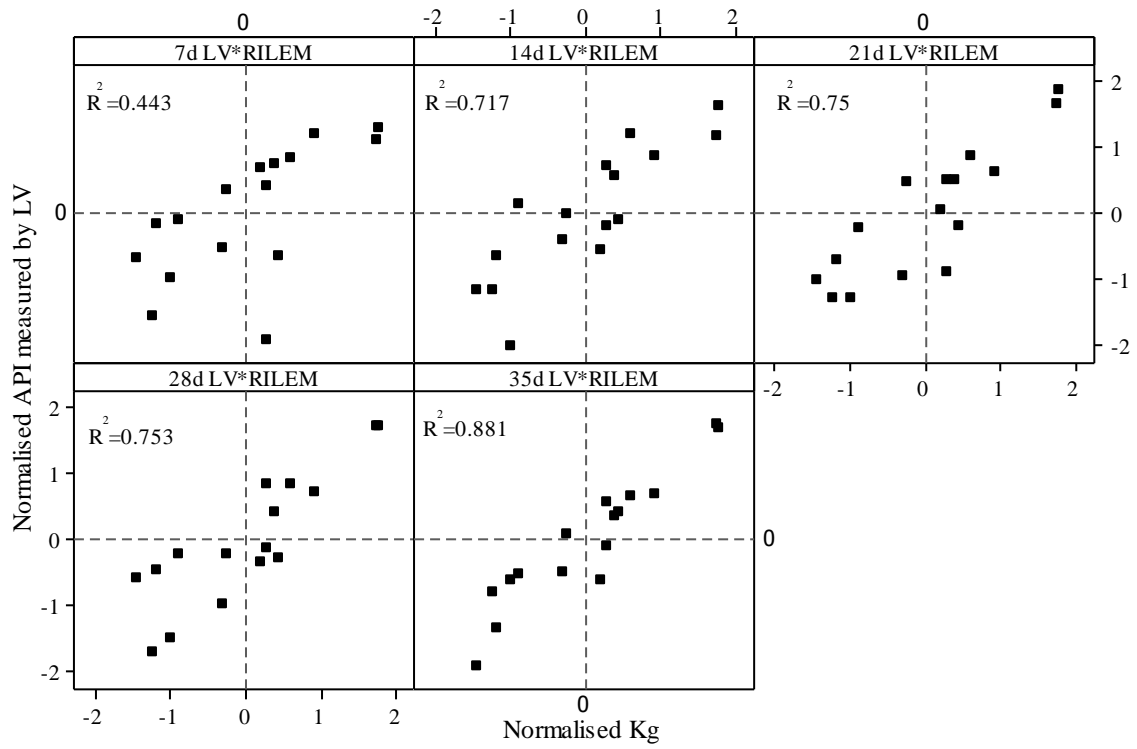

Figure 9 Effect of drying on relationship between LV and RILEM permeability tests

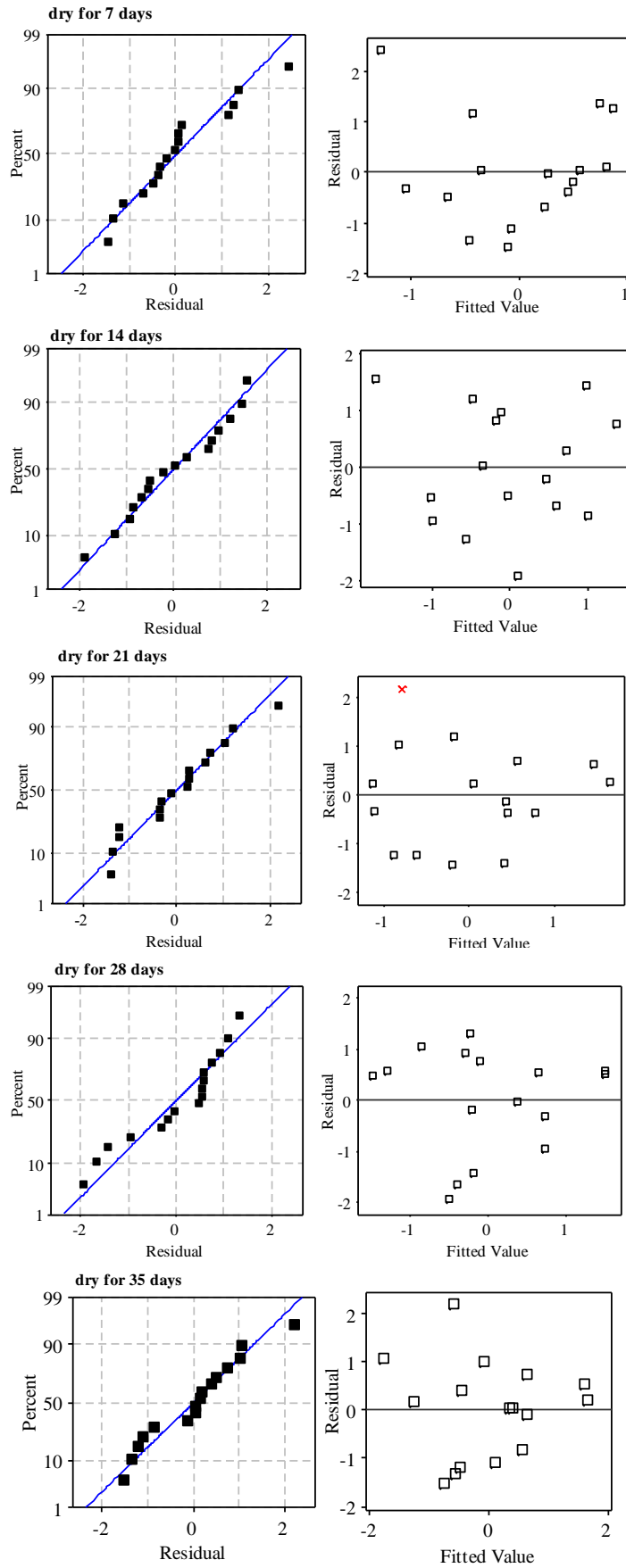

Figure 10 Diagnostic plots of regression analysis for LV test