



Experimental study of a diesel engine heat pump in heating mode for domestic retrofit application

Shah, N., Huang, M. J., & Hewitt, N. (2016). Experimental study of a diesel engine heat pump in heating mode for domestic retrofit application. *Applied Thermal Engineering*, 98, 522-531.
<https://doi.org/10.1016/j.applthermaleng.2015.12.006>

[Link to publication record in Ulster University Research Portal](#)

Published in:
Applied Thermal Engineering

Publication Status:
Published (in print/issue): 05/04/2016

DOI:
[10.1016/j.applthermaleng.2015.12.006](https://doi.org/10.1016/j.applthermaleng.2015.12.006)

Document Version
Author Accepted version

General rights

The copyright and moral rights to the output are retained by the output author(s), unless otherwise stated by the document licence.

Unless otherwise stated, users are permitted to download a copy of the output for personal study or non-commercial research and are permitted to freely distribute the URL of the output. They are not permitted to alter, reproduce, distribute or make any commercial use of the output without obtaining the permission of the author(s).

If the document is licenced under Creative Commons, the rights of users of the documents can be found at <https://creativecommons.org/share-your-work/licenses/>.

Take down policy

The Research Portal is Ulster University's institutional repository that provides access to Ulster's research outputs. Every effort has been made to ensure that content in the Research Portal does not infringe any person's rights, or applicable UK laws. If you discover content in the Research Portal that you believe breaches copyright or violates any law, please contact pure-support@ulster.ac.uk

1 Experimental study of a diesel engine heat pump in heating 2 mode for domestic retrofit application

3 N.N. Shah^{1,*}, M.J. Huang^{*}, N.J. Hewitt^{*}

4 **Centre for Sustainable Technologies, University of Ulster, Newtownabbey, Co. Antrim, BT37 0QB,*
5 *UK*

6 Abstracts

7 An engine driven heat pump (ENHP) can provide better efficiency compared to electric heat
8 pump (EHP) considering primary energy consumption. The present work aimed to find
9 suitability of diesel engine heat pump as a domestic retrofit application for off or weak
10 gas/electricity network area. For this project work, water-to-water heat pump test facility was
11 developed which consisted heat pump, diesel engine and heat recovery arrangements. The
12 system performance was evaluated for 65°C flow temperature from condenser at three
13 different engine speeds (1600, 2000 & 24000 rpm) and four evaporator water inlet
14 temperature (0, 5, 10 & 15°C). The system performance was evaluated by heating capacity,
15 isentropic efficiency, coolant heat recovery, exhaust gas heat recovery and PER.
16 Performance analyses showed that heat recovery contributed 33% in total heat output where
17 heat recovery was in a range of 1.7 to 3.7 kW. PER varied in the range of 0.9 to 1.4 showing
18 good potential in terms of 35-65% primary energy saving and 23-42% CO₂ emissions
19 reduction compared to conventional system. DEHP optimisation showed ability to meet
20 water flow temperature requirement of 65-73°C by speed variations and heat recovery
21 providing good potential to meet heating demand during winter and summer periods in
22 retrofit settings.

23

24 *Key words:* Heat pump, DEHP, Retrofit, Water source, Heat recovery, Diesel engine

25 1 Introduction

26 In order to address global issues of greenhouse gases (GHGs) emission, climate change,
27 depleting fossil fuel resource and security of supply; sustainable growth which includes
28 increased share of renewable energy and efficient technology is essential. Heat pump based
29 on vapour compression cycle is such efficient and mature technology which can provide
30 heating/cooling/DHW in domestic, commercial and industrial sector. Mostly, heat pumps
31 driven by electric motor are known as electric heat pump (EHP). However, heat pump can
32 be driven by gas/diesel/stirling engine too. The concept of engine driven heat pump (ENHP)
33 was developed during 1970s in order to balance gas and electricity demand during winter
34 and summer. ENHP concept was presented by Colosimo (1987) where he showed benefits
35 of waste heat utilisation from the engine to improve overall efficiency compared to EHPs [1].
36 From the year 1980 to 2015, data gathered from the ISI Web of Knowledge, it was found that
37 almost 115 articles have been published in scientific Journals and/or conferences related to
38 engine heat pump system. The published articles mainly consisted, simulation, experimental
39 analysis, controller side, thermodynamic analysis and novel application with other
40 technology etc. From the concept to product development, various investigation and
41 applications have been presented through literatures.

¹ Corresponding author: Tel: +44 (0) 2890366122; Fax: +44 (0) 2890368239.
Email: n.shah@ulster.ac.uk (N.N. Shah)

1 For example, Hepbasli, et al. (2009) [2] have presented a review on gas engine heat pump
2 application in residential and industrial sector. ENHPs advantages over EHPs due to heat
3 recovery and engine speed modulation have been presented by various authors [3] [4] [5] [6]
4 [7] [8]. Gas engine heat pump performance in heating, cooling and for hot water production
5 have been discussed by Elgendy's research group showing influence of
6 condenser/evaporator inlet/outlet temperature and engine speed variation on heating/cooling
7 capacity and primary energy ratio [9] [10] [11]. In addition, few other investigations are on
8 simulation/thermodynamic analysis and experimental work together. For example, Yang et
9 al. (2013) presented simulation and experimental result of GEHP for water heating
10 application that showed that GEHP operation reduced running cost and emission in a range
11 of 30-37% compared to gas boiler [12]. Similarly, Zhang et al. (2005) presented steady stage
12 model based on experimental and manufactures data for air-to-water heat pump in heating
13 mode showing 30% waste heat recovery contribution in total heat output at rated conditions
14 [13].

15 Hence, from literature it was found that the most of studies have been carried out on gas
16 engine, air-to-water heat pump and commercial/industrial application. There is not enough
17 investigation on diesel engine based water-to-water heat pump or ENHPs for retrofit
18 application in domestic sector. In addition, Lian et al. (2005) showed that there is no current
19 water-to-water based engine heat pump readily available in the market and they presented
20 benefits of gas engine heat pump with water loop system with reduced payback period [14].
21 Additionally, the main market players of engine heat pump system are from ASIA (mainly
22 Japan) with capacity from 14 to 175 kW [15]. Hence, there is no current manufacture from
23 Europe or small-scale engine heat pump system, which can provide heating capacity in a
24 range of 10 kW, a typical house heating demand of UK dwelling.

25 In addition, despite having higher efficiency, heat pumps are not so common in the UK due
26 to gas and electricity price and other factor of poor insulation, housing stock, weather etc.
27 [16]. Moreover, in the UK domestic sector, gas and oil boilers are most common technology
28 for providing space heating and domestic hot water (DHW) through central heating system
29 that contributes almost 78% in domestic energy consumption and 40% domestic heat related
30 emission [17] [18]. For a retrofit technology (e.g. heat pump), it needs to meet certain criteria
31 to replace existing heating system as existing wet radiator system requires higher flow
32 temperature to meet their heat demand [19]. In addition, poorly insulated housing stock in
33 the UK influences sizing of heat pump and EHPs vast deployment (10-20% penetration)
34 would require attention to existing electricity distribution network [20] [21]. EHP requires high
35 start-up current whereas most of houses in the UK have single-phase supply that may add
36 further cost to the system [16]. In domestic sector, along with electricity consumption, natural
37 gas consumption is the most dominant as fuel to provide space heating and hot water.
38 Natural gas supply and demand side has also issues due to reducing resources. Natural gas
39 production is decreasing in the UK where UK has become net importer of natural gas since
40 2005 instead of net exporter [22]. In addition, there is a limitation of gas and electricity
41 network and further extension or new production requires huge investment.

42 Hence, in order to address above mentioned issues, experimental study on diesel engine
43 heat pump (DEHP) based on water-to-water source has been presented in this paper. The
44 novelty of this work presents in terms of capacity (small scale; less than 10 kW), water-to-
45 water source heat pump, domestic retrofit application and potential for off gas grid area with
46 possible use of renewable sources. The selection of diesel engine proves beneficial due to
47 higher compression ratio and higher density of diesel fuel compared to gas/petrol engine. In
48 addition, there is possibility to use vegetable oil, biodiesel or waste oil with diesel engine,

1 which could make it technology based on renewable sources. Generally, vegetable oil or
2 biodiesel has higher viscosity than diesel fuel that affects engine performance and
3 components [23]. However, pre-heating such oil helps to reduce viscosity and makes it
4 possible to use such vegetable oil, biodiesel or waste oil in diesel engine directly. Pradhan et
5 al. (2014) used waste heat from exhaust gas to preheat *Jatropha curcas* oil to improve fuel
6 properties that helped to reduce emissions [24]. Similarly, many other investigators used
7 waste heat from exhaust gas and/or jacket water to improve fuel properties of various fuels
8 for diesel engine [25] [26] [27] [28]. Hence, it shows good operational potential in remote are
9 or off-gas grid network area to use vegetable oil or waste oil with possible use of waste heat
10 recovery when not used for heating/DHW.

11 The diesel engine was modified and fitted with low temperature thermostat along with other
12 heat recovery arrangement in order to run with water-to-water source heat pump. This paper
13 presents detailed performance analysis of DEHP showing influence of engine speed and
14 evaporation temperature on heating/cooling capacity, primary energy ratio, isentropic
15 efficiency, coolant heat recovery and exhaust heat recovery. In addition, DEHP performance
16 was compared with conventional technology to show potential in terms of primary energy
17 and CO₂ emission savings.

18 **2 Experimental set-up**

19 *2.1 Design consideration*

20 Diesel engine driven heat pump (DEHP) design and component selection criteria are
21 dependent on many parameters. However, the most important parameter is heating
22 load/demand along with other parameters such as function, thermal comfort, temperature
23 requirement, heat loss, size, mobility, ergonomics, maintenance, monitoring, control and
24 total cost etc. Heat demand in the domestic sector is mainly for space heating and for hot
25 water. Heat demand varies based on type of dwellings, sizes, occupants, etc. For the
26 development of laboratory test set-up heating load and DHW demand was taken into
27 consideration. Huang et al., (2007) presented the heating demand for a typical three
28 bedroom 105m² test-houses in Carrickfergus, Northern Ireland [29]. Figure 1 shows the
29 house heat demand against ambient temperature curve. The heating demand (including hot
30 water) varied from 8.5 kW at -10°C to 4.2 kW at 20°C. The demand side management and
31 capacity control both play vital roles at different ambient conditions. Therefore, considering
32 these points the DEHP system was designed to meet house heat demand of 7.1 kW at 0°C
33 ambient temperature. This can supply hot water in a temperature range of 55°C to 65°C
34 (more suitably, above 60°C to avoid legionella formation) in existing wet radiator hydronic
35 system as a retrofit technology. Based on heating demand all components of DEHP system
36 such as the engine, compressor, heat exchanger etc. have been selected. Water-to-water
37 heat pump was designed to see their feasibility with context to ground source heat pump as
38 well.

39

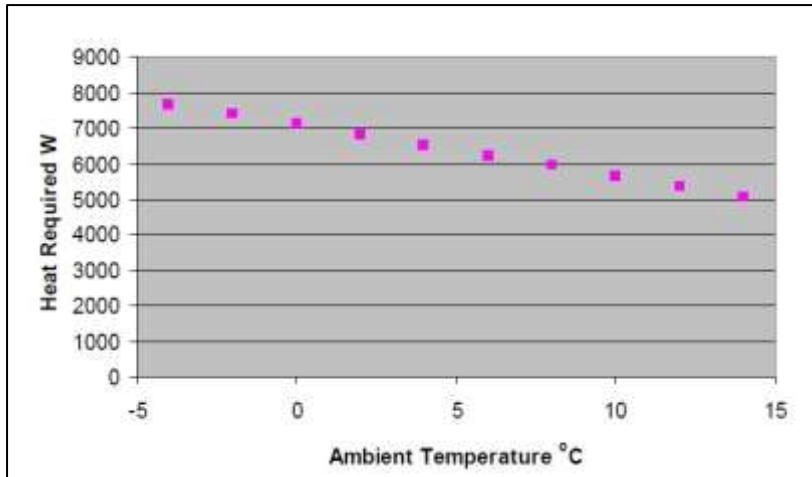

1
2 **Figure 1 Typical house heating demand (incl. DHW demand) [29]**

3 *2.2 Experimental apparatus*

4 In order to develop experiment test-rig, the diesel engine was selected considering
 5 parameters such as: 1.) small capacity diesel engine to meet domestic house demand, 2.)
 6 direct coupling option, 3.) sourced locally for ease of parts and technical help 4.) ease of
 7 modification for low temperature thermostat, 5.) torque, speed and orientation
 8 (horizontal/vertical) to match compressor. Based on those considerations, a commercially
 9 available diesel engine Kubota EB300-E [30] was selected to drive open reciprocating
 10 compressor with help of flexible coupling to work with R134a refrigerant. The selected diesel
 11 engine was water-cooled with maximum speed of 3000 rpm at which it gives 4.14 kW
 12 continuous power output. The compressor has a speed range between 750- 3000 rpm which
 13 matches speed range of the engine too. A low temperature thermostatic valve was placed on
 14 the engine as a modification from thermosyphon cooling to forced circulation water-cooling
 15 which enables heat recovery from the engine coolant at above 60°C. A brazed plate heat
 16 exchanger was used as condenser, evaporator and coolant heat recovery heat exchanger
 17 whereas shell-tube heat exchanger used to recover heat from the exhaust gas. A schematic
 18 of DEHP set-up has been shown Figure 2 where it shows the arrangement of various
 19 components and instrumentations for DEHP system. Hot and cold water temperature in
 20 secondary circuit was managed with the help of PID controlled third circuit which manages
 21 desired inlet/outlet temperature conditions at evaporator and condenser whereas additional
 22 heat was emitted to air via fan-coil heat exchanger. Temperatures, pressure, flow rate and
 23 speed were measured at various points in the line of heat pump, heat recovery and the
 24 engine side and all measured data were logged in data acquisition system. Measurement
 25 accuracy of temperature, pressure, flow rate and speed was in the range of ± 0.15 K, $\pm 1\%$,
 26 $\pm 1\%$ and $\pm 1\%$ respectively. Data were logged every 15s and stored for data analysis
 27 purpose with data acquisition system.

28

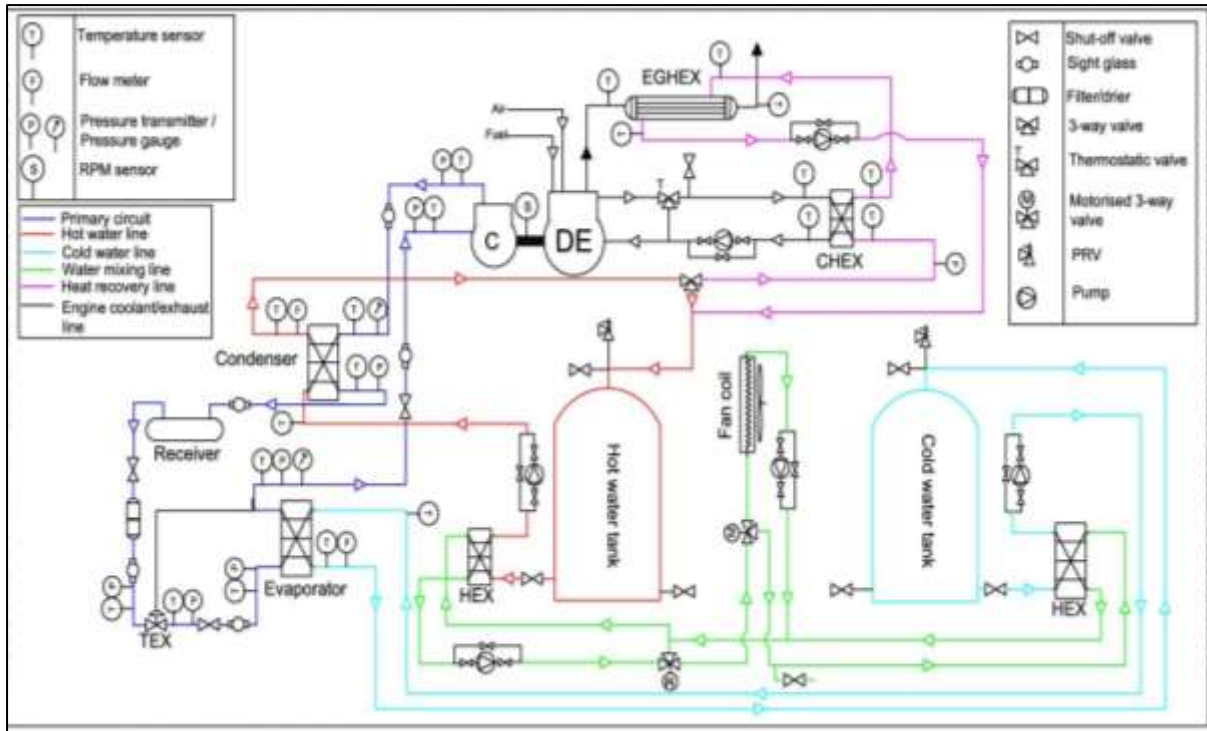

1
2 **Figure 2 DEHP test setup with heat recovery arrangement**

3 **2.3 Experimental method and procedure**

4 DEHP system performance was evaluated with test standard similar to EHPs as there is no
5 current European test standard that covers water-to-water based ENHP system. For DEHP
6 testing, British standard EN 14511 [31] was taken as a reference for DEHP testing. The
7 system was tested for flow temperature at 35°C, 45°C, 55°C and 65°C with varying
8 evaporator water inlet temperature at 0°C, 5°C, 10°C and 15°C. At standard conditions all
9 test were carried out at fixed engine speed of 1600 rpm and in the same way test were
10 repeated at 2000 rpm and 2400 rpm conditions. Based on experiment data; heating
11 capacity, cooling capacity, compressor power consumption, coolant heat recovery, exhaust
12 gas heat recovery, primary energy ratio, isentropic efficiency, engine efficiency were
13 calculated using equations 1 to 8 [10] [32].

14 $Q = m C \Delta T = m_{ref} \Delta h$ 1

15 $P_c = m_{ref} \Delta h$ 2

16 $COP = \frac{Q_c}{P_c}$ 3

17 $Q_t = Q_c + Q_{CHR} + Q_{EHR}$ 4

18 $Q_f = m_f H.H.V.$ 5

19 $PER = \frac{Q_t}{Q_f}$ 6

20 $\eta_i = \frac{h_{ds} - h_s}{h_{da} - h_s}$ 7

$$\eta_e = \frac{P_c}{Q_f}$$

3 Results and discussion

DEHP system performance analysis involves performance of three sub-systems such as engine, heat recovery and heat pump system. Performance analyses at various speed and evaporation temperature have been discussed in following section in details.

3.1 Heat pump performance

DEHP system test baseline test were carried out at 1600 rpm to obtain flow rate as per standard and after that it was kept constant for other evaporation temperature and speed of 2000 and 2400 rpm. Various parameters were calculated from experimental data for 65 °C flow temperature at condenser outlet. Figure 3 shows change in heating and cooling capacity of heat pump with variation of speed and evaporation water inlet temperature. Heating capacity varies between 3.64 kW to 7.71 kW whereas cooling capacity varies between 2.1 kW to 4.89 kW during entire test conditions. Heating capacity increases by 13% with increasing engine speed whereas heating capacity increases by 20% with increasing evaporation temperature. Heat output is around 4.54 kW at 2400 rpm and 0 °C evaporator water inlet conditions. Hence, only heat output from condenser would not be able to meet house heating demand of 7.1 kW at 0 °C and heat recovery from the engine can play significant role to meet house heating demand at desired flow temperature. In order to check experimental data, it was compared with compressor selection software for a similar test conditions which showed 18% deviation from software value. This lower heat output occurred due to heat loss, pressure drop and condenser/evaporator effectiveness.

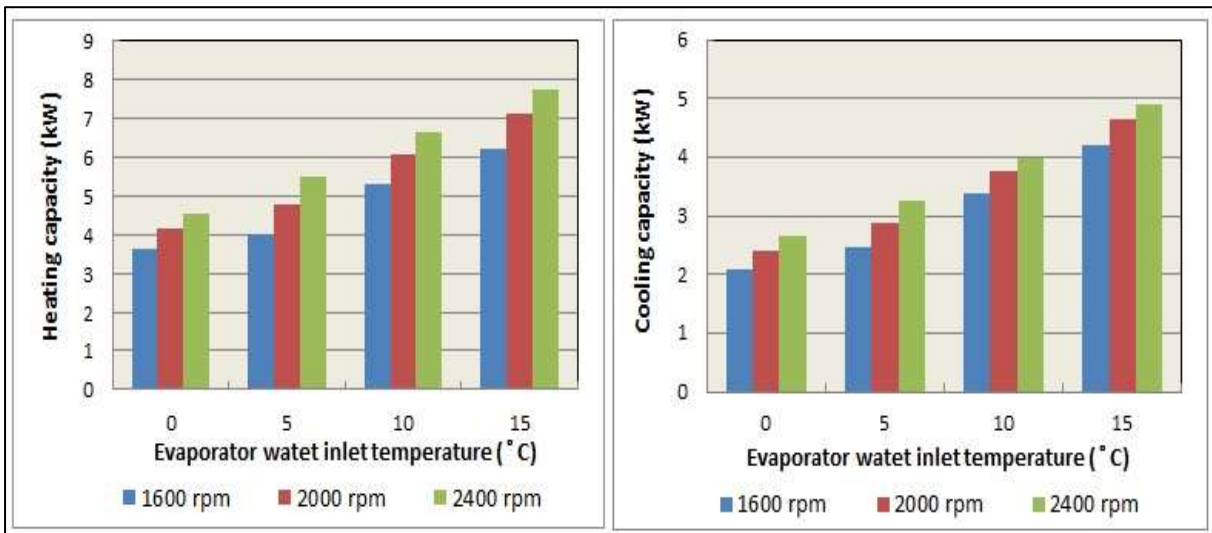

22
23 **Figure 3 Condensing and evaporating capacity variation with speed for 65 °C flow temperature**

24 In addition to heating/cooling capacity, variation in discharge temperature was monitored
 25 whereas isentropic efficiency was calculated from experimental data. Figure 4 shows
 26 discharge temperature and isentropic efficiency variation with respect to speed and
 27 evaporation temperature. Speed increment has huge impact on discharge temperature as
 28 discharge temperature increases with increasing engine speed whereas influence of
 29 evaporation temperature increment shows reverse trend. Discharge temperature decreases
 30 with increasing evaporation temperature and it is true for all speed conditions. Isentropic
 31 efficiency (IE) analysis shows that IE is higher at lower speed due to reduced heat losses

1 and IE drops as speed increases. However, evaporation temperature does not show any
 2 clear influence on isentropic efficiency as it remains same for same flow conditions. Thus, it
 3 is better to run heat pump system at lower possible speed in order to achieve higher
 4 isentropic efficiency.

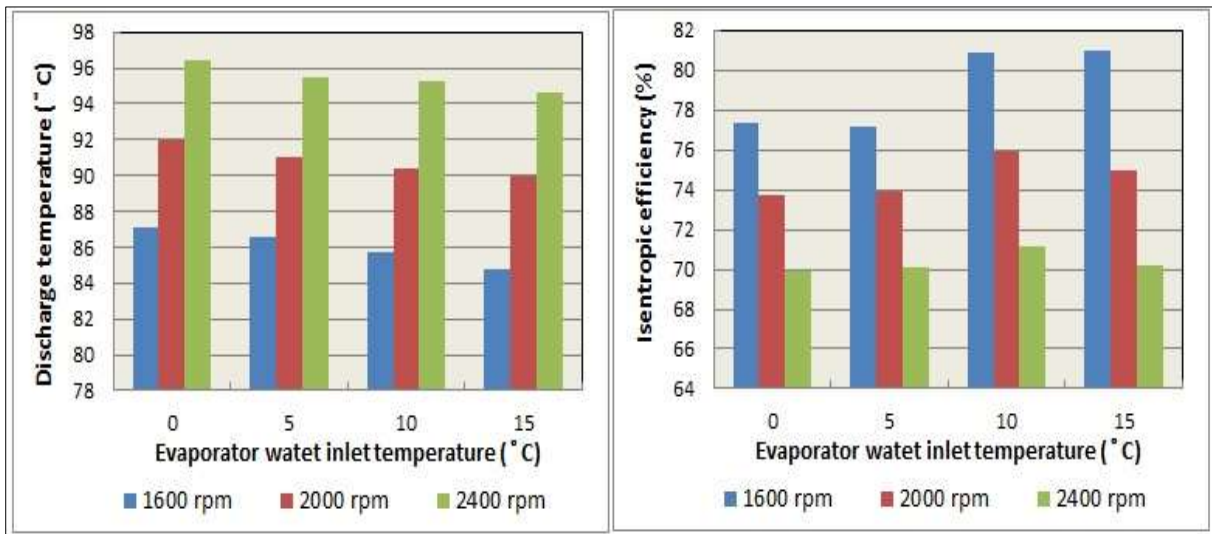

5
 6 **Figure 4 Discharge temperature and isentropic efficiency variation with speed for 65°C flow temperature**

7 Other parameters such as refrigerant mass flow rate, power consumption and COP of heat
 8 pump were calculated indirectly from heating/cooling capacity and enthalpy difference at
 9 various test conditions. From calculation, it is found that refrigerant mass flow rate increases
 10 with speed and evaporation temperature. Similarly, compressor power consumption
 11 increases with increasing speed and evaporation temperature due to increased pressure
 12 ratio and refrigerant mass flow rate that also reflects in COP outcome. COP analysis shows
 13 that COP varies in a range of 2.36 to 3.13. COP increases with evaporation temperature
 14 whereas it decreases with increasing engine speed which shows similar trend compared to
 15 other EHPs. However, for DEHP, primary energy ratio (PER) is appropriate measure than
 16 COP, hence, PER variation with engine speed and evaporation temperature has been
 17 discussed in more detail in later section.

18 3.2 Diesel engine performance including heat recovery

19 Diesel engine performance is mainly influenced by condensing/evaporating temperature and
 20 speed of the engine. The compressor power demand decides load on the engine, fuel
 21 consumption and heat recovery from the engine. In addition, airflow rate and fuel flow rate
 22 are decided by engine geometry based on load/speed conditions. Diesel fuel flow rate with
 23 higher heating value gives fuel energy input for the DEHP system. Fuel input energy at the
 24 diesel engine is considered as 100% and heat recovery, engine efficiency and losses are
 25 balanced based on their percentage share for the engine at give point. Figure 5 shows
 26 variation of fuel energy input, total heat recovery, heat recovery from coolant and exhaust
 27 gas. Fuel input energy increases by 20% with increasing engine speed (e.g. 1600 to 2000
 28 rpm or 2000 to 2400 rpm). However, evaporation temperature influence on fuel flow rate (or
 29 fuel input energy) is not very significant as compared to engine speed variation. Fuel flow
 30 rate increases by 8% while increasing evaporation temperature.

31 The increment in fuel energy input influences heat recovery and losses in energy balances.
 32 Total heat recovery increases by 22% with each step speed increment whereas total heat
 33 recovery increases by 16% with increasing evaporation temperature by 5K. Total heat

1 recovery remains between 1.7 to 3.7 kW. The share of coolant heat recovery is higher
 2 compared to exhaust heat recovery in total heat recovery. Coolant H.R. varies between 1.2
 3 to 2.2 kW whereas exhaust H.R. varies between 0.5 to 1.5 kW. Both coolant H.R. and
 4 exhaust H.R. increases with increasing engine speed and evaporation temperature.
 5 However, exhaust H.R. increases by 36%, whereas coolant H.R. increases by 15% with
 6 speed increment. Similarly, coolant H.R. increases by 14% and exhaust H.R. increases by
 7 19% with evaporation temperature. Thus, from heat recovery point of view, it is better to run
 8 engine at higher speed and at higher evaporation temperature.

9

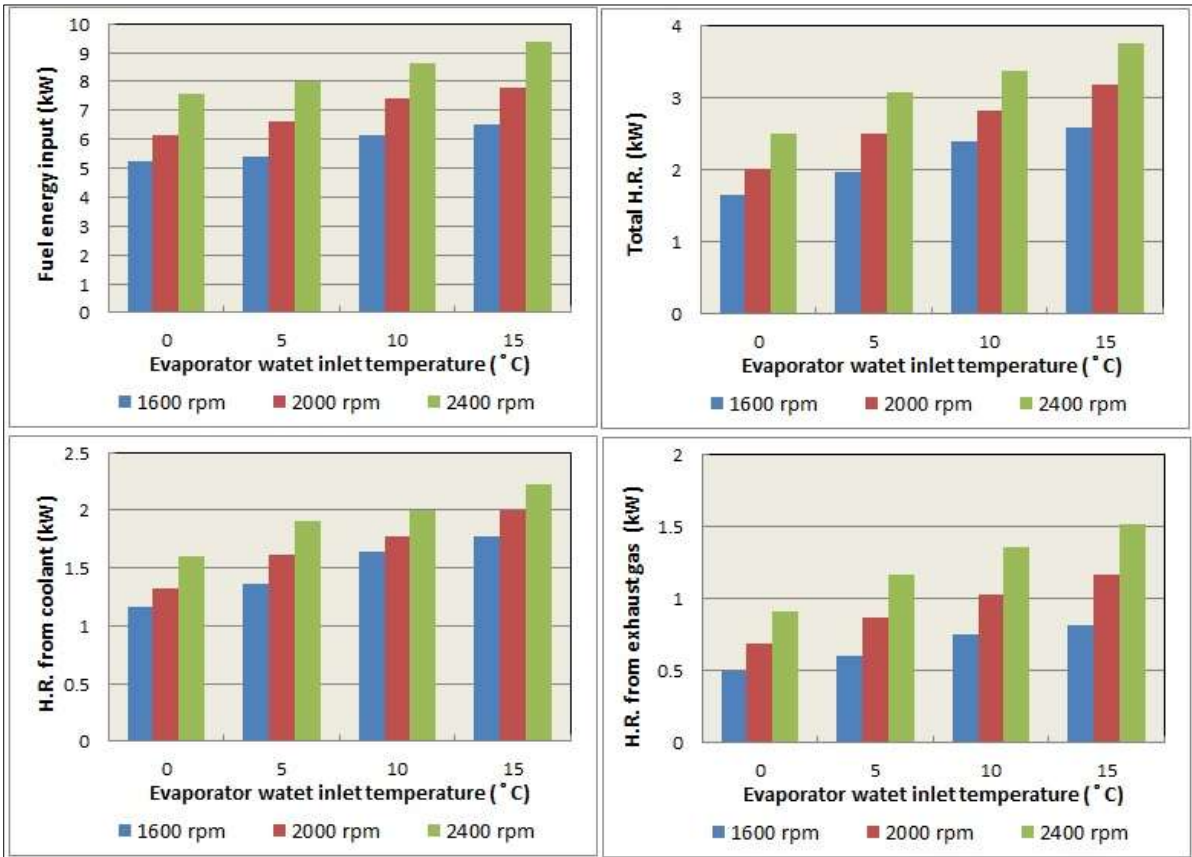

10

11

12

Figure 5 Diesel engine performance in terms of heat recovery and fuel energy input for 65°C flow temperature

13

14

15

16

17

18

In addition, diesel engine energy balance was calculated based on experimental data where losses from the engine were balanced from fuel energy input (100%) to heat recovery and engine shaft power. Figure 6 show the diesel engine energy balance based on experimental data and shaft power calculation. It is evident that the losses from the engine decreases as evaporation temperature increases due to engine efficiency. However, speed increment does not show any clear influence on the losses from the engine.

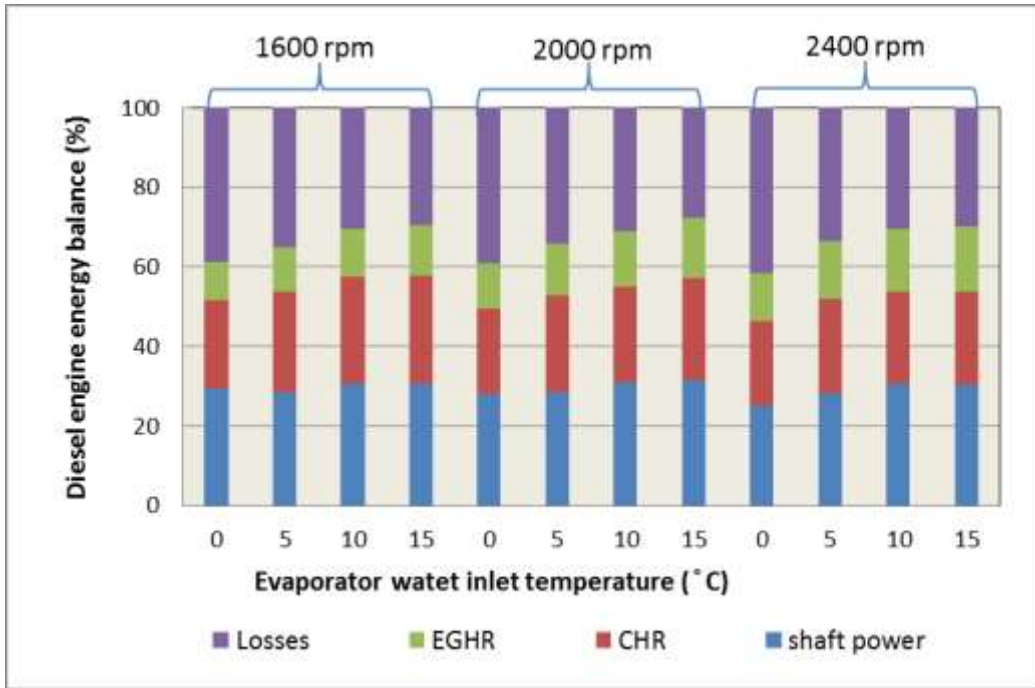

1
2 **Figure 6 Diesel engine energy balance**

3 **3.3 Overall DEHP system performance**

4 Overall DEHP performance analysis includes total heat output from the system, heat
 5 recovery % share and primary energy ratio where PER gives overall efficiency of the DEHP
 6 system. Total heat output includes condenser heat output and heat recovered from the
 7 engine. Figure 7 shows total heat output of DEHP system and percentage of heat recovery
 8 in total heat output. Total heat output from DEHP system varies between 5.3 to 11.5 kW
 9 where heat output for 0°C evaporation temperature is 7.05 at 2400 rpm speed. Hence,
 10 DEHP system can meet house-heating demand at 0°C with the help of heat recovery. Total
 11 heat output increases by 16% and 18% with increasing speed and evaporation temperature
 12 respectively. This increment in heating capacity is mainly due to increment in condensing
 13 capacity at higher evaporation temperature and speed. Hence, it is better to operate DEHP
 14 system at possible higher speed and at higher evaporation temperature in total heat output
 15 point of view.

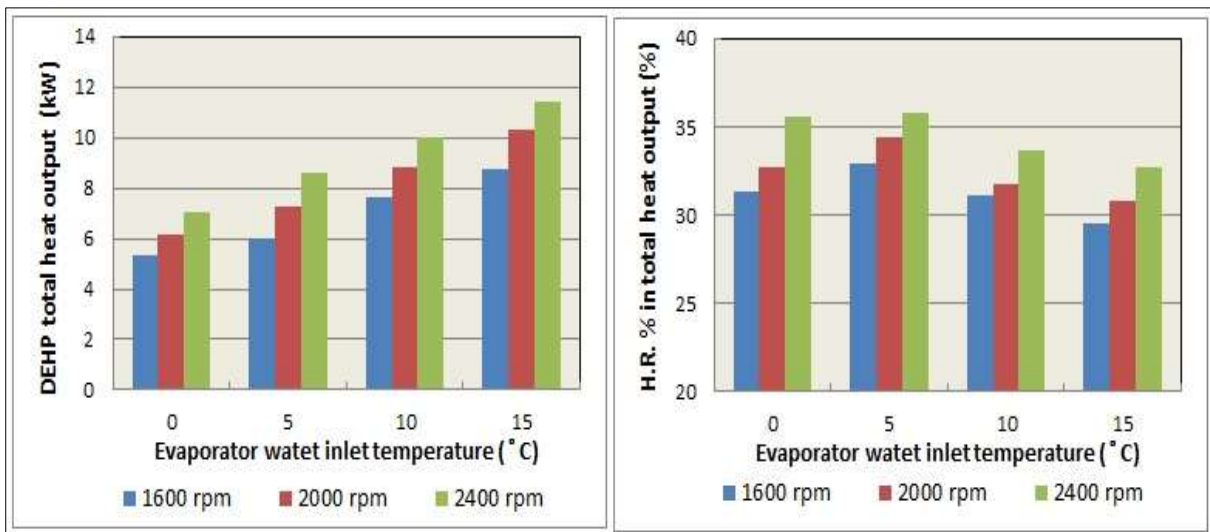

16
17 **Figure 7 DEHP total heat output and heat recovery % in total heat output**

1 However, heat recovery percentage in total heat output shows a different trend for
 2 evaporation temperature. The share of HR ranges from 29 to 36% in total heat output where
 3 H.R. (%) share decreases with increment of evaporation temperature and H.R. (%) share
 4 increases with engine speed. Decrement in H.R. percentage is due to increased condensing
 5 capacity at higher speed and evaporation temperature.
 6 Primary energy ratio has similar trend as total heat output. Figure 8 shows variation in PER.
 7 PER varies in a range of 0.9 to 1.4. PER increases by 10% whereas it decreases by 4% with
 8 increasing evaporation temperature and engine speed receptively. PER is lower at higher
 9 speed due to increased fuel input energy compared to total heat output. On contrary, PER
 10 increases with increasing evaporation temperature due to increased heat output from heat
 11 pump and load on the engine which gives higher total heat output compared to fuel energy
 12 input. Thus, in order to get higher PER value, it is better to run system at best possible lower
 13 speed. However, at lower speed DEHP system may not be able to meet desired heating
 14 load. It is important to find balance between speed and heat load demand in order to run
 15 system in the most efficient way.

16

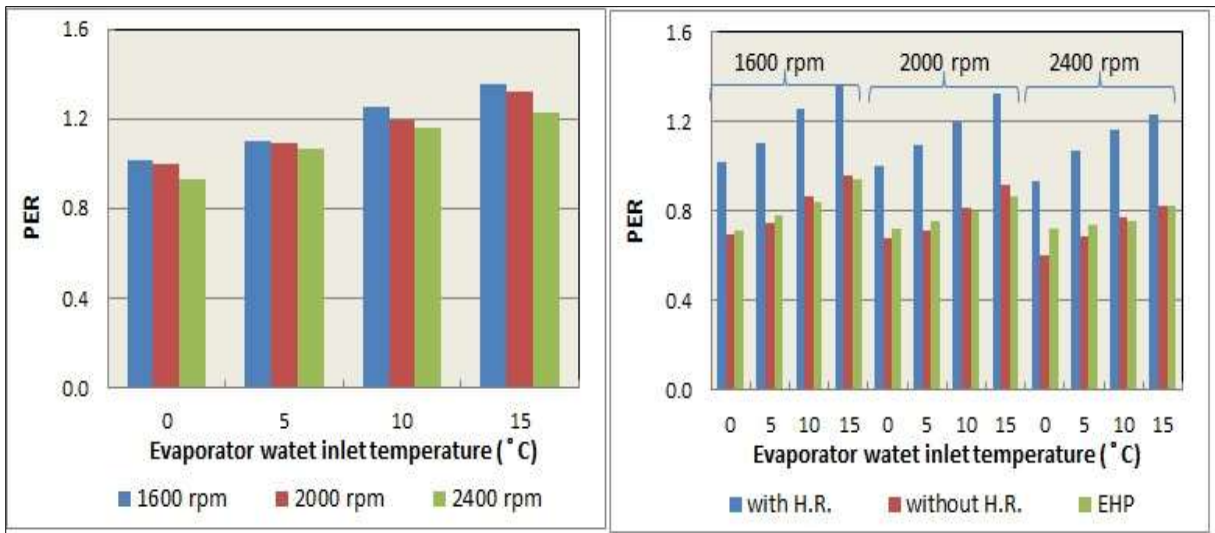

17

18 **Figure 8 Primary energy ratio and comparison with EHP and without H.R. for DEHP**

19 In addition, PER comparison is done with similar kind EHP system to present benefits of
 20 heat recovery compared to DEHP without H.R. and EHPs. Figure 8 shows PER comparison
 21 in three case scenarios. It is clear that DEHP system does not give any benefit without heat
 22 recovery whereas DEHP without H.R. provides almost similar or less performance compared
 23 to EHPs. DEHP system with heat recovery provides 30 to 53% higher PER compared to
 24 similar EHPs. In order to understand overall DEHP system performance in terms of energy
 25 input and output energy balance has been prepared. Figure 9 shows overall energy balance
 26 for DEHP system. For analysis purpose, two extreme conditions of minimum and maximum
 27 PER has been illustrated. At minimum PER conditions, losses from the engine increase
 28 significantly which is mainly due to reduced evaporating and condensing capacity and load
 29 on the engine. Maximum PER conditions mainly benefits from improved condensing capacity
 30 at higher evaporation temperature rather than heat recovery.

31

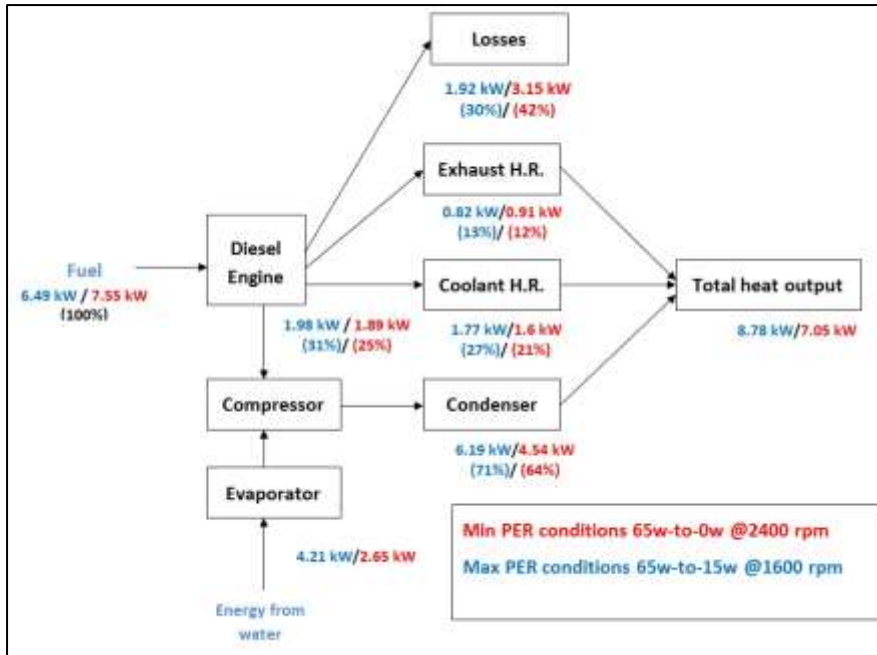

1
2 **Figure 9 DEHP system energy balance for min & max PER conditions**

3 **3.4 DEHP optimisation for domestic application**

4 In order to meet house-heating demand in summer and wintertime, capacity modulation is
 5 essential to improve thermal comfort in the house, efficiency and system components life.
 6 On the other side, final water outlet temperature from DEHP system plays important role for
 7 retrofit application to meet space heating DHW demand. In test set-up, water outlet from
 8 condenser was fed to heat recovery unit via three-way valve. Hence, water outlet
 9 temperature from heat recovery system is always higher than condenser water outlet. For all
 10 test conditions, final water temperature from DEHP system remains between 65 to 73°C
 11 where almost 97% water passes from condenser outlet to heat recovery unit; giving final flow
 12 rate in a range of 7 to 10 l/min. Figure 10 shows achievable final water temperature and flow
 13 rate from DEHP system considering retrofit application. Hence, DEHP system can be used
 14 with conventional radiators that require high water temperature from the heating system.

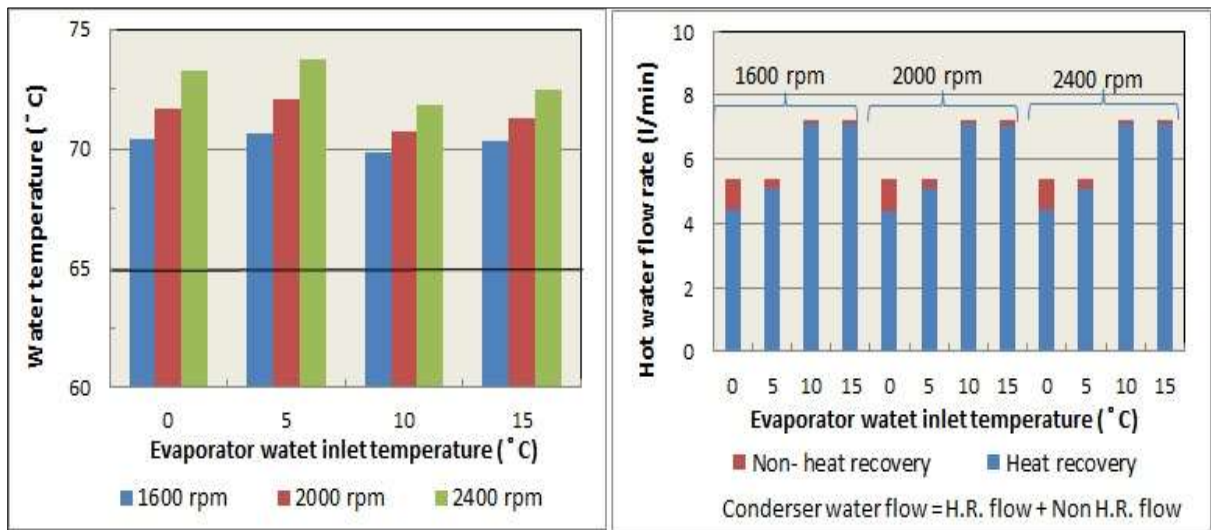

15
16 **Figure 10 Achievable water temperature and flow rate from DEHP system due to H.R.**

1 In order to assess DEHP performance for better capacity control, experiments data were
 2 matched with house heating demand at respective temperature. Figure 11a shows balance
 3 point at three different engine speed of 1600, 2000 and 2400 rpm with respect to heating
 4 demand. It gives balance point near 6°C, 3°C and 0°C at 1600, 2000 and 2400 rpm
 5 respectively. Any heating demand on left side of balance points calls for back-up heat and
 6 heating demand on right side of balance point calls for heat output reduction or system shut
 7 off due to excess heat. Considering this behaviour, it was found that with 400-rpm increment
 8 balance point shifts by 3°C and it was confirmed with selection software too. Based on it,
 9 flexible speed DEHP heat output was simulated to match heating demand of the house. With
 10 flexible speed scenario, DEHP can meet house-heating demand at air temperature of -4.5°C
 11 to 9°C. Even at higher air temperature (above 14°C), all heat demand can be satisfied with
 12 waste heat recovery only without running a heat pump. Figure 11b shows comparison
 13 between estimated variable speed (yellow curve) and three speed (red) DEHP to meet
 14 house-heating demand (blue curve). Hence, DEHP variable speed option shows great
 15 potential to reduce cycling losses and improved thermal comfort.
 16

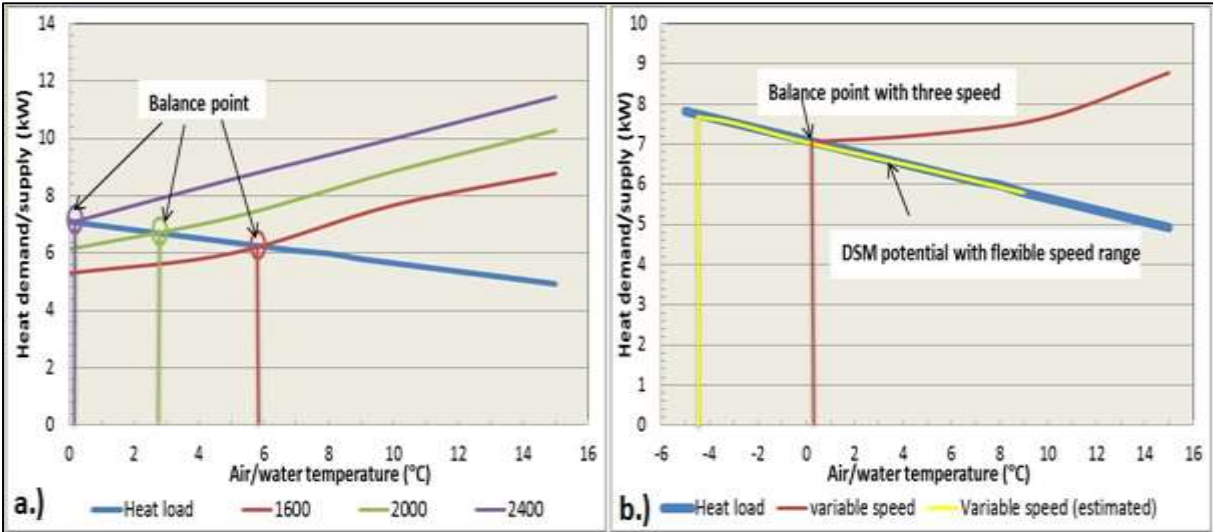

17
 18 **Figure 11 DEHP system balance point: a.) with three fixed speed; b.) variable speed scenario**

19 **3.5 Emission and economic comparison**

20 The DEHP performance has been compared with conventional technologies such as gas/oil
 21 boiler, electric heating and EHP in order to evaluate emission, primary energy and cost
 22 savings. A comparison has been done to meet annual heating demand of 3000kWh where
 23 net electricity supply efficiency is taken as 35%, heat pump COP taken as 2.5, diesel engine
 24 efficiency is taken as 30% whereas thermal efficiency is assumed 45% (heat recovery).
 25 GHGs emissions are calculated from DEFRA greenhouse gas emission factor [33] and oil
 26 boiler performance is taken as a reference. The result obtained from comparison has been
 27 tabulated and it can be seen from

28 Table 1. Based on annual primary energy consumption and fuel price, annual heating cost
 29 and savings has been compared (Table 2). A comparison results shows that electric heating
 30 is the most inefficient way to meet house demand in terms of primary energy consumption
 31 and emissions. EHP is helpful in terms of primary energy consumption savings however,
 32 emissions is still higher compared to oil boiler. Apart from electric heating, all other heating
 33 technologies are able to save money. Taking a case scenario of DEHP system efficiency of

1 80% (includes electrical and thermal efficiency) gives higher annual fuel cost saving
 2 compared to gas boiler. This efficiency is still lower compared to commercially available CHP
 3 unit from Honda that has declared efficiency of 85% [34].
 4

5 **Table 1 Primary energy and emission saving comparison**

<i>Heating system</i>	<i>Efficiency (%)</i>	<i>Annual energy input device (kWh)</i>	<i>at</i>	<i>Total primary energy input (kWh)</i>	<i>Annual CO₂e emission (kg)</i>	<i>Primary energy saving (%)</i>	<i>CO₂e emission saving (%)</i>
Gas boiler	90	3333		3333	677	12.22	38.55
Oil boiler	79	3797		3797	1101	-	-
Electric heater	100	3000		8571	4714	-125.73	-328.11
Electric heat pump (EHP)	250	1200		3429	1886	9.69	-71.27
Diesel engine heat pump (DEHP)	75	840		2800	840	35.61	23.71
DEHP with 30% biodiesel	75	840		1960	714	48.38	35.16
DEHP with 50% biodiesel	75	840		1400	630	63.13	42.79
DEHP with 100% biodiesel	75	840			420	100.00	61.86
*Oil boiler is taken as a base case							

6

7 **Table 2 Annual cost saving comparison**

<i>Heating system</i>	<i>Fuel price (pence/kWh)</i>	<i>Annual cost (£)</i>	<i>Cost saving (%)</i>
Gas boiler	4.5	150	40
Oil boiler	6.6	251	-
Electric heater	14.5	435	-73
EHP	14.5	174	31
DEHP 75% eff.	6.6	185	26
DEHP 80% eff.	6.6	145	42
*Average fuel price sourced from [35]			

8 **4 Conclusion**

9 DEHP system test results showed that DEHP is able to meet house-heating demand with
 10 help of heat recovery. Compared to fixed speed EHPs, DEHPs have obvious advantages of
 11 variable speed and heat recovery. DEHP can provide high temperature water (e.g. 55-75°C)
 12 which is main requirement for high temperature wet radiator system as a retrofit application.
 13 DEHP system heat output and percentage of heat recovery increases with speed whereas

1 isentropic efficiency, COP and PER decreases with speed increment. Thus, it is important to
 2 find right balance points between various parameters in order to achieve optimum
 3 performance of the system. A comparative analysis shows that DEHP provides 39-65%
 4 higher heat output, 26-62% higher PER compared to EHP system. Heat recovery share in
 5 total heat output varies from 28-39%. DEHP system has potential to save primary energy,
 6 CO₂ emissions and annual fuel cost in a range of 35-65%, 23-42% and 26-42% respectively
 7 compared to oil boiler. Main issues of high initial cost can be solved by government support
 8 and mass production of advanced engine/compressor unit which can lower the engine cost
 9 in the range of 50£/kW in order to provide better power to heat ratio making it more attractive
 10 as co-generation unit for domestic application. Use of bio-diesel, vegetable oil and/or waste
 11 oil in DEHP has good potential to use heat recovery for fuel process. Overall, DEHPs vast
 12 implementation in off/weak gas/electricity area can reduce primary energy consumption,
 13 emissions and fossil fuel diversion in domestic sector in order to achieve national emission
 14 reduction target with increased share of renewable energy and thermal/electrical energy
 15 storage.

16 **5 Acknowledgement**

17 The author would like to thank Science Foundation Ireland - The Charles Parsons Energy
 18 Research Award for their financial support

19 **Nomenclature**

20 *Abbreviations*

21 ENHP	Engine driven heat pump
22 DEHP	Diesel engine driven heat pump
23 GHP/GEHP	Gas engine driven heat pump
24 EHP	Electric heat pump
25 PER	Primary energy ratio
26 COP	Coefficient of performance
27 H.H.V.	Higher heating value of fuel (MJ/kg)
28 HEX	Heat exchanger
29 TEX	Thermostatic expansion valve
30 DE	Diesel engine
31 H.R.	Heat recovery
32 CHR	Coolant heat recovery
33 EGHR	Exhaust gas heat recovery

34 *Symbols*

35 Q	Heat output (kW)
36 m	Mass flow rate of heat transfer fluid (kg/s)
37 ΔT	Temperature difference (K)
38 P _C	Compressor power consumption (kW)
39 m _{ref}	Refrigerant mass flow rate (kg/s)
40 Δh	Enthalpy difference (kJ/kg)
41 Q _C	Condenser heat output (kW)
42 Q _t	Total heat output of DEHP system (kW)
43 Q _{CHR}	Coolant heat recovery (kW)
44 Q _{EHR}	Exhaust gas heat recovery (kW)
45 Q _f	Diesel fuel energy input (kW)

1	m_f	Diesel fuel mass flow rate (kg/s)
2	η_i	Isentropic efficiency (%)
3	h_{ds}	Isentropic enthalpy at discharge (kJ/kg)
4	h_s	Suction enthalpy (kJ/kg)
5	h_{da}	Actual enthalpy at discharge (kJ/kg)
6	η_e	Diesel engine efficiency (%)

7 6 References

8

- [1] D. D. Colosimo, "Introduction to engine-driven heat pumps- Concepts, Approach and Economics," *ASHRAE Transactions*, vol. 3, no. 1, pp. 987-996, 1987.
- [2] A. Hepbasli, Z. Erbay, F. Icier, N. Colak and E. Hancioglu, "A review of gas engine driven heat pumps (GEHPs) for residential and industrial applications," *Renewable and Sustainable Energy Reviews*, vol. 13, pp. 85-99, 2009.
- [3] J. Parise and W. Cartwright, "Experimental Analysis of a Diesel Engine Driven Water-to-Water Heat Pump," *Heat Recovery Systems & CHP*, vol. 8, no. 2, pp. 75-85, 1988.
- [4] M. D'Accadia, M. Sasso and S. Sibilio, "Field Test Of A Small Size Gas Engine Driven Heat Pump In An Office Application: First Results," *International Journal of Ambient Energy*, vol. 16, no. 4, pp. 183-191, 1995.
- [5] F. Cascetta, M. Sasso and S. Sibilio, "A Metrological Analysis Of The In-Situ Evaluation Of The Performance Of A Gas Engine Driven Heat Pump," *Measurements*, vol. 16, no. 4, pp. 209-217, 1995.
- [6] J. Brenn, P. Soltic and C. Bach, "Comparison of Natural Gas Driven Heat Pumps and Electrically Driven Heat Pumps with Conventional Systems for Building Heating Purposes," *Energy and Buildings*, vol. 42, no. 6, pp. 904-908, 2010.
- [7] A. Zaltash, P. Geoghegan, E. Vineyard, R. Wetherington, R. Linkous and I. Mahderekal, "Laboratory Evaluation: Performance of a 10 RT GAs-Engine-Driven Heat Pump (GHP)," *ASHRAE Transactions*, vol. 114, no. 2, pp. 224-230, 2008.
- [8] G. Nowakowski, M. Inada and M. Dearing, "Development And Field Testing Of A High-Efficiency Engine-Driven Gas Heat Pump For Light Commercial Applications," *ASHARA E Transactions*, vol. 98, no. 1, pp. 994-1000, 1992.
- [9] E. Elgendy, J. Schmidt, A. Khalil and M. Fatouh, "Performance of a Gas Engine Driven Heat Pump for Hot Water Supply Systems," *Energy*, vol. 36, no. 5, pp. 2883-2889, 2011.
- [10] E. Elgendy, J. Schmidt, A. Khalil and M. Fatouh, "Performance of a Gas Engine Heat Pump (GEHP) using R410A for Heating and Cooling Applications," *Energy*, vol. 35, no. 12, pp. 4941-4948, 2010.
- [11] E. Elgendy and J. Schmidt, "Experimental Study of Gas Engine Driven Air to Water Heat Pump in Cooling Mode," *Energy*, vol. 35, no. 6, pp. 2461-2467, 2010.
- [12] Z. Yang, W. Wang and X. Wu, "Thermal modelling and operating tests for a gas-engine driven heat pump working as a water heater in winter," *ENERGY AND BUILDINGS*, vol. 58, pp. 219-226, 2013.
- [13] R. Zhang, X. Lu, S. Li, W. Lin and A. Gu, "Analysis on the Heating Performance of a Gas Engine Driven Air to Water Heat Pump Based on A Steady State Model," *Energy Conversion and Management*, vol. 46, no. 11-12, pp. 1714-1730, 2005.

- [14] Z. Lian, S. Park, W. Huang, Y. Baik and Y. Yao, "Conception of Combination of Gas Engine-Driven Heat Pump and Water-Loop Heat Pump System," *International Journal of Refrigeration*, vol. 28, no. 6, pp. 810-819, 2005.
- [15] PHP, "Promotion of efficient heat pumps for heating (ProHeatPump)," 2009. [Online]. Available: <http://www.proheatpump.eu/Downloads/>. [Accessed 5 12 2011].
- [16] H. Singh, A. Muetze and P. Eames, "Factors influencing the uptake of heat pump technology by the UK domestic sector," *Renewable Energy*, vol. 35, no. 4, pp. 873-878, 2010.
- [17] DECC, "Emission from Heat: Statistical Summary," Department of Energy & Climate Change, London, 2012a.
- [18] DUKES, "Digest of United Kingdom Energy Statistics," A National Statistics publication for Department of Energy and Climate Change (DECC), London, 2012a.
- [19] N. Hewitt, M. J. Huang, M. Anderson and M. Quinn, "Advanced air source heat pump for UK and European domestic buildings," *Applied Thermal Engineering*, vol. 31, no. 17-18, pp. 3713-3719, 2011.
- [20] M. Akmal, B. Fox, D. Morrow and T. Littler, "Impact of high penetration of heat pumps on low voltage distribution networks," 2011.
- [21] P. Mancarella, C. Gan and G. Strabac, "Evaluation of the impact of electric heat pumps and distributed CHP on LV networks," 2011.
- [22] DECC, "Gas Statistics: Table 4.2 & 4.3 Natural gas import, export, production and supply," Department of Energy & Climate Change, London, 2012b.
- [23] M. Karabektas, G. Ergen and M. Hosoz, "The effects of preheated cottonseed oil methyl ester on the performance and exhaust emissions of a diesel engine," *Applied Thermal Engineering*, vol. 28, no. 17-18, pp. 2136-2143, 2008.
- [24] P. Pradhan, H. Raheman and D. Padhee, "Combustion and performance of a diesel engine with preheated *Jatropha curcas* oil using waste heat from exhaust gas," *Fuel*, vol. 115, pp. 527-533, 2014.
- [25] S. Bari, T. Lim and C. Yu, "Effects of preheating of crude palm oil (CPO) on injection system, performance and emission of a diesel engine," *Renewable Energy*, vol. 27, no. 3, pp. 339-351, 2002.
- [26] B. Chauhan, N. Kumar, Y. Jun and K. Lee, "Performance and emission study of preheated *Jatropha* oil on medium capacity diesel engine," *Energy*, vol. 35, no. 6, pp. 2484-2492, 2010.
- [27] M. Pugazhvadivua and M. Jeyachandranb, "Investigations on the performance and exhaust emissions of a diesel engine using preheated waste frying oil as fuel," *Renewable Energy*, vol. 30, no. 14, pp. 2189-2202, 2005.
- [28] A. Hossain and P. Davies, "Performance, emission and combustion characteristics of an indirect injection (IDI) multi-cylinder compression ignition (CI) engine operating on neat *jatropha* and *karanj* oils preheated by jacket water," *Biomass and Bioenergy*, vol. 46, pp. 332-342, 2012.
- [29] M. Huang, H. NJ and M. N, "Field testing of an economised vapour injection heat pump," in *22nd IIR International Congress of Refrigeration*, Beijing, China, 2007.
- [30] Kubota, "Kubota.co.uk," Engine, 2014. [Online]. Available: <http://www.kubota.co.uk/product-range/engines-uk/product-range/single-cylinder->

series/eb300/. [Accessed 5 January 2014].

- [31] BSI, "EN14511: Air conditioners, liquid chilling packages and heat pumps with electrically driven compressors for space heating and cooling (Part 1-4)," BSI, 2013.
- [32] R. Radermacher and Y. Hwang, Vapor Compression Heat Pumps with Refrigerant Mixtures, FL: CRC Press, Taylor & Francis Group, 2005.
- [33] DEFRA, "Greenhouse Gas Conversion Factor," Department for Environment Food and Rural Affairs, London, 2009.
- [34] G. Simader, R. Krawinkler and G. Trnka, "Buildup.eu (Micro CHP System: State-of-the-art)," 30 September 2010. [Online]. Available: <http://www.buildup.eu/publications>. [Accessed 29 January 2011].
- [35] CAE, "Confused about energy," 2013. [Online]. Available: <http://www.confusedaboutenergy.co.uk/index.php/domestic-fuels>. [Accessed 10 April 2013].

1

2